

---

**U.S. ARMY MEDICAL DEPARTMENT CENTER AND SCHOOL  
FORT SAM HOUSTON, TEXAS 78234-6100**

---

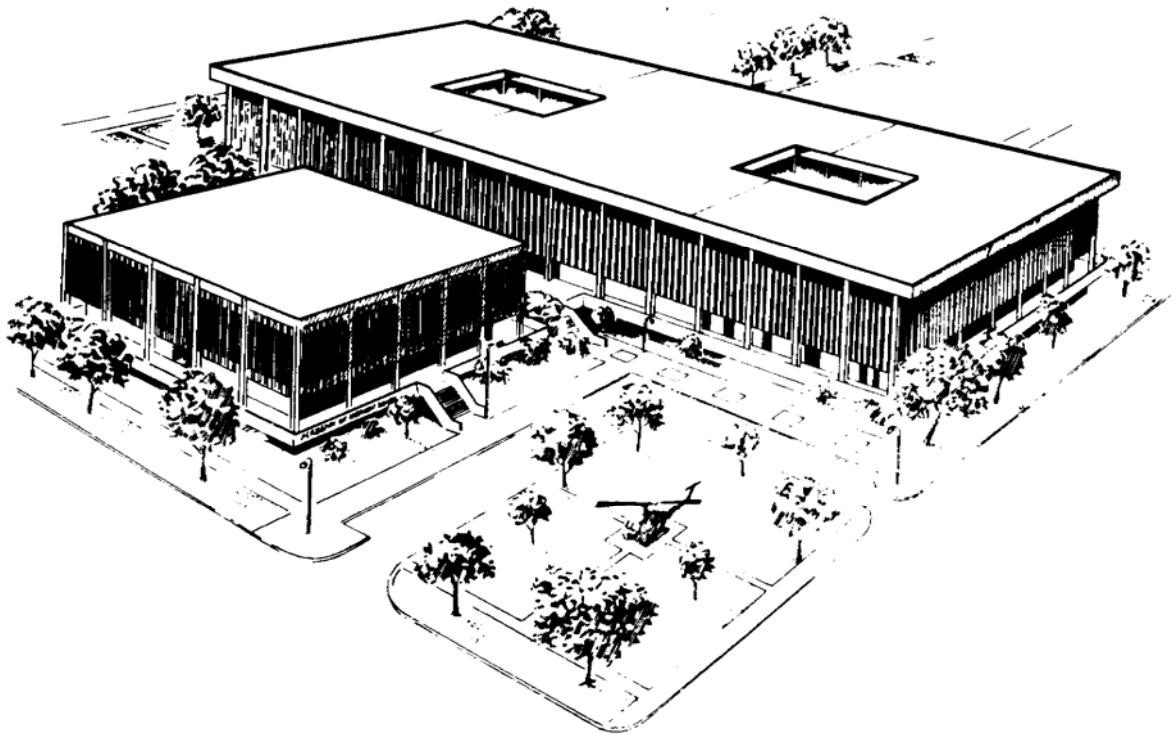

# **SHELL EGGS**

**SUBCOURSE MD0713**

**EDITION 100**

## **DEVELOPMENT**

This subcourse is approved for resident and correspondence course instruction. It reflects the current thought of the Academy of Health Sciences and conforms to printed Department of the Army doctrine as closely as currently possible. Development and progress render such doctrine continuously subject to change.

The subject matter expert responsible for content accuracy of this edition was the NCOIC, Nursing Science Division, DSN 471-3086 or area code (210) 221-3086, M6 Branch, Academy of Health Sciences, ATTN: MCCS-HNP, Fort Sam Houston, Texas 78234-6100.

## **ADMINISTRATION**

Students who desire credit hours for this correspondence subcourse must meet eligibility requirements and must enroll in the subcourse. Application for enrollment should be made at the Internet website: <http://www.atrrs.army.mil>. You can access the course catalog in the upper right corner. Enter School Code 555 for medical correspondence courses. Copy down the course number and title. To apply for enrollment, return to the main ATRRS screen and scroll down the right side for ATRRS Channels. Click on SELF DEVELOPMENT to open the application and then follow the on screen instructions.

For comments or questions regarding enrollment, student records, or examination shipments, contact the Nonresident Instruction Branch at DSN 471-5877, commercial (210) 221-5877, toll-free 1-800-344-2380; fax: 210-221-4012 or DSN 471-4012, e-mail [accp@amedd.army.mil](mailto:accp@amedd.army.mil), or write to:

NONRESIDENT INSTRUCTION BRANCH  
AMEDDC&S  
ATTN: MCCS-HSN  
2105 11TH STREET SUITE 4191  
FORT SAM HOUSTON TX 78234-5064

## **CLARIFICATION OF TERMINOLOGY**

When used in this publication, words such as "he," "him," "his," and "men" are intended to include both the masculine and feminine genders, unless specifically stated otherwise or when obvious in context.

## TABLE OF CONTENTS

<u>Lesson</u>		<u>Paragraphs</u>
	INTRODUCTION	
1	SHELL EGG INTRODUCTION AND INSPECTION EQUIPMENT	
	Section I. Formation of the Egg	1-1--1-9
	Section II. Preparing a Candling Room and Assembling Egg Inspection Equipment.	1-10--1-14
	Exercises	
2	DESTINATION INSPECTION OF SHELL EGGS	
	Section I. Introduction	2-1--2-4
	Section II. Sampling Data	2-5--2-7
	Section III. Identity Inspection	2-8--2-11
	Section IV. Condition Inspection	2-12--2-17
	Exercises	
3	CLASSIFYING AND GRADING SHELL EGGS	
	Section I. Quality Factors for Grading/Classifying	3-1--3-19
	Section II. Standards for Quality	3-20--3-24
	Exercises	
4	COMPLETION OF SHELL EGG INSPECTION AND THE RECORDING OF RESULTS ON THE DD FORM 1237	
	Section I. Additional Inspection Procedures	4-1--4-4
	Section II. The DD Form 1237, Report of Inspection of Shell Eggs	4-5--4-7
	Exercises	
5	SURVEILLANCE INSPECTION OF SHELL EGGS	5-1--5-8
	Exercises	

## LIST OF TASKS TAUGHT

<u>Task Number</u>	<u>Task Title</u>	<u>Lesson</u>
081-892-1084	Prepare Candling Room and Assemble Egg Inspection Equipment	1
081-892-1149	Inspect Shell Eggs at Destination (Classes 4 and 8)	2, 3, 4
081-892-1085	Select Samples for Egg Inspection	2, 4
081-892-1155	Perform a Surveillance Inspection of Shell Eggs	5

**CORRESPONDENCE COURSE OF  
THE U.S. ARMY MEDICAL DEPARTMENT CENTER AND SCHOOL**

**SUBCOURSE MD0713**

**SHELL EGGS**

**INTRODUCTION**

The egg, it should be remembered, is a biological structure intended by nature for reproduction of the chicken. It protects and provides a complete diet for the developing chick embryo and serves as the principal source of food for the first few days of the baby chicken's life. The egg is one of the most nutritious and versatile of human foods. As chickens now produce eggs in abundance, this source of food has become extremely important throughout the world, nutritionally as well as economically.

Subcourse Components:

The subcourse instructional material consists of the following:

- Lesson 1, Shell Egg Introduction and Inspection Equipment.
- Lesson 2, Destination Inspection of Shell Eggs.
- Lesson 3, Classifying and Grading Shell Eggs.
- Lesson 4, Completion of Shell Egg Inspection and the Recording of Results on the DD Form 1237.
- Lesson 5, Surveillance Inspection of Shell Eggs.

Here are some suggestions that may be helpful to you in completing this subcourse:

- Read and study each lesson carefully.
- Complete the subcourse lesson by lesson. After completing each lesson, work the exercises at the end of the lesson, marking your answers in this booklet.
  
- After completing each set of lesson exercises, compare your answers with those on the solution sheet that follows the exercises. If you have answered an exercise incorrectly, check the reference cited after the answer on the solution sheet to determine why your response was not the correct one.

**Credit Awarded:**

To receive credit hours, you must be officially enrolled and complete an examination furnished by the Nonresident Instruction Branch at Fort Sam Houston, Texas. Upon successful completion of the examination for this subcourse, you will be awarded 15 credit hours.

You can enroll by going to the web site <http://atrrs.army.mil> and enrolling under "Self Development" (School Code 555).

A listing of correspondence courses and subcourses available through the Nonresident Instruction Section is found in Chapter 4 of DA Pamphlet 350-59, Army Correspondence Course Program Catalog. The DA PAM is available at the following website: <http://www.usapa.army.mil/pdffiles/p350-59.pdf>.

## **LESSON ASSIGNMENT**

### **LESSON 1**

Shell Egg Introduction and Inspection Equipment.

### **TEXT ASSIGNMENT**

Paragraphs 1-1 through 1-15.

### **LESSON OBJECTIVES**

After completing this lesson, you should be able to:

- 1-1. Identify the physical structure of an egg and the process by which the parts of an egg are formed.
- 1-2. Identify the correct procedures for preparing an egg candling room and assembling egg inspection equipment.

### **SUGGESTION**

After studying the assignment, complete the exercises of this lesson. These exercises will help you to achieve the lesson objectives.

## LESSON 1

### SHELL EGG INTRODUCTION AND INSPECTION EQUIPMENT

#### Section I. FORMATION OF THE EGG

##### 1-1. INTRODUCTION

a. The Defense Personnel Support Center purchased over 100 million dozen shell eggs each year during the height of our participation in the Vietnam War. Who was responsible to assure that the government received its dollar's worth of nutrition? That responsibility was with the United States (US) Army Veterinary Service. Shell eggs are probably the only item of subsistence on which you, the veterinary food inspection specialist, must make a grade determination at destination. Shell eggs, like any other item of subsistence, cannot be graded until the factors that contribute to the grading system are known and understood. The terms used to describe an egg are not necessarily Webster, rather, they are the language of the trade, and you must know those of and understand them so that you can properly grade eggs.

b. You must know about eggs, egg quality, and grading procedures. Such knowledge of the "what" and "how" of the job, together with good judgment, practice, and guidance from experienced supervisors, will enable you to acquire the necessary skills to determine the proper classification of shell eggs according to official standards of quality. To begin with, we will provide some background information on the formation, structure, and composition of an egg so that you will be better able to determine the classification of eggs.

##### 1-2. REPRODUCTIVE SYSTEM

The reproductive system of a hen consists of the ovary and the oviduct (see figure 1-1).

a. **Ovary.** The right ovary is not functional. The left ovary, located directly beneath the backbone opposite the last two ribs, secretes a hormone that aids in balancing the body's glandular system, stores egg yolks, and regulates their release. When a hen is hatched, the ovary contains its lifetime complement of yolk cells--3600 to 4000. Each mature yolk is composed of the germ spot (germinal disc), a fatty substance known as yolk, and the yolk membrane, called the vitelline membrane. When a hen reaches sexual maturity, the yolks begin to mature one at a time. During this maturation process, a large amount of fatty substance is deposited in the sac formed by the vitelline membrane (see figures 1-2 and 1-3). When the yolk is mature, the sac ruptures and allows the yolk to escape. This rupture usually occurs along an avascular zone known as the stigma, which has practically no blood vessels or nerves (the remainder of the capsule has an abundant supply). The release of the yolk, called ovulation, occurs again about 30 minutes after a finished egg has been laid. During the laying "clutch" of a high-producing hen, ovulation can occur as often as every 22 hours.



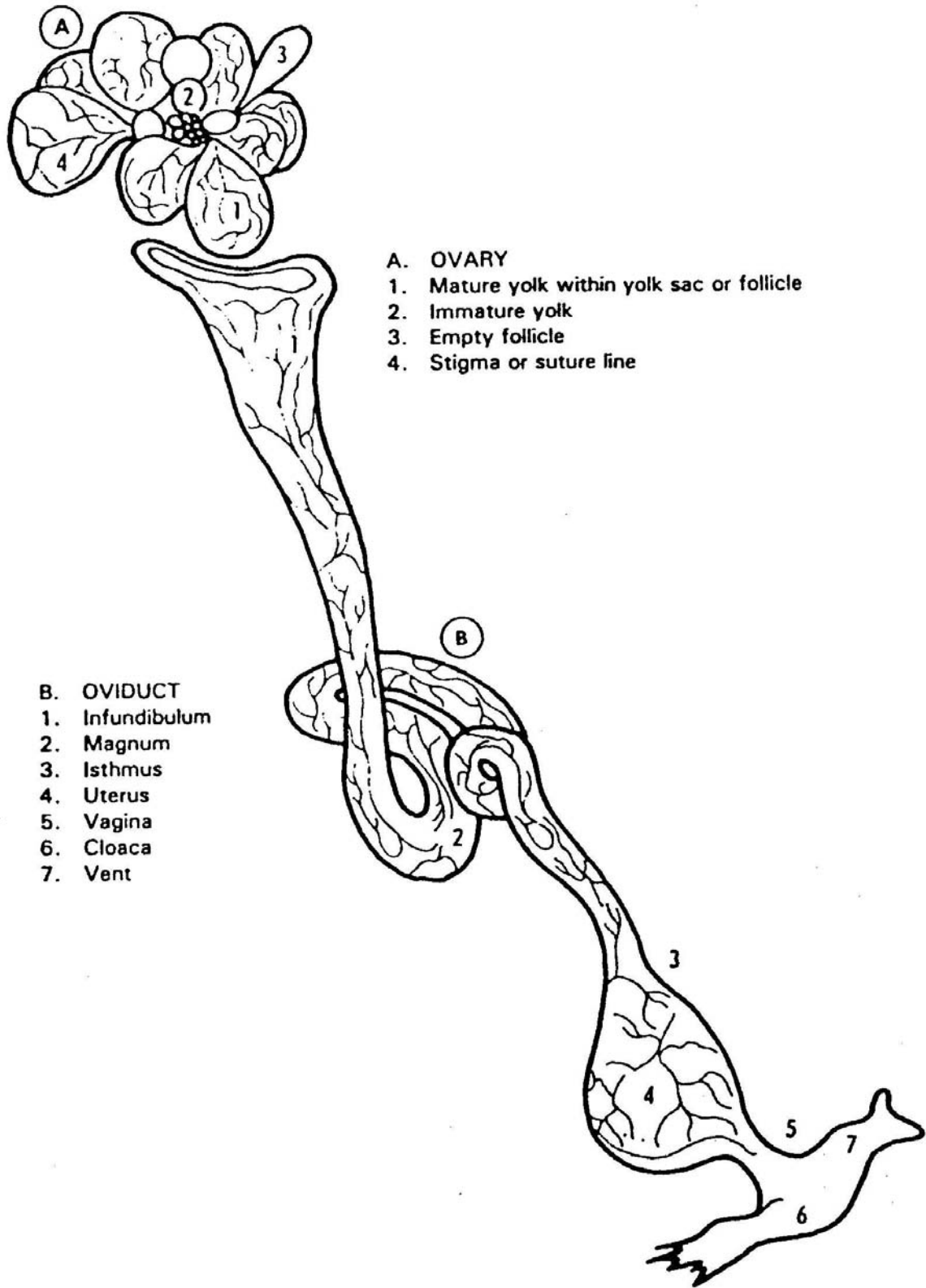

Figure 1-1. Reproductive tract.

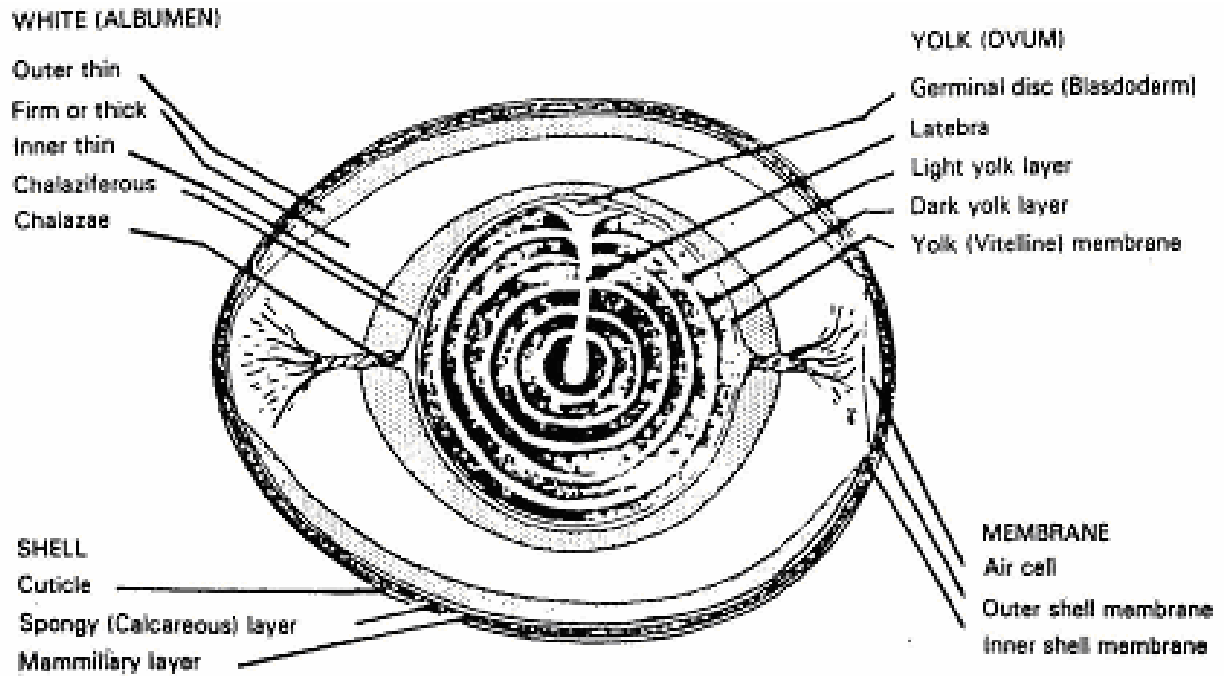

Figure 1-2. The parts of an egg.

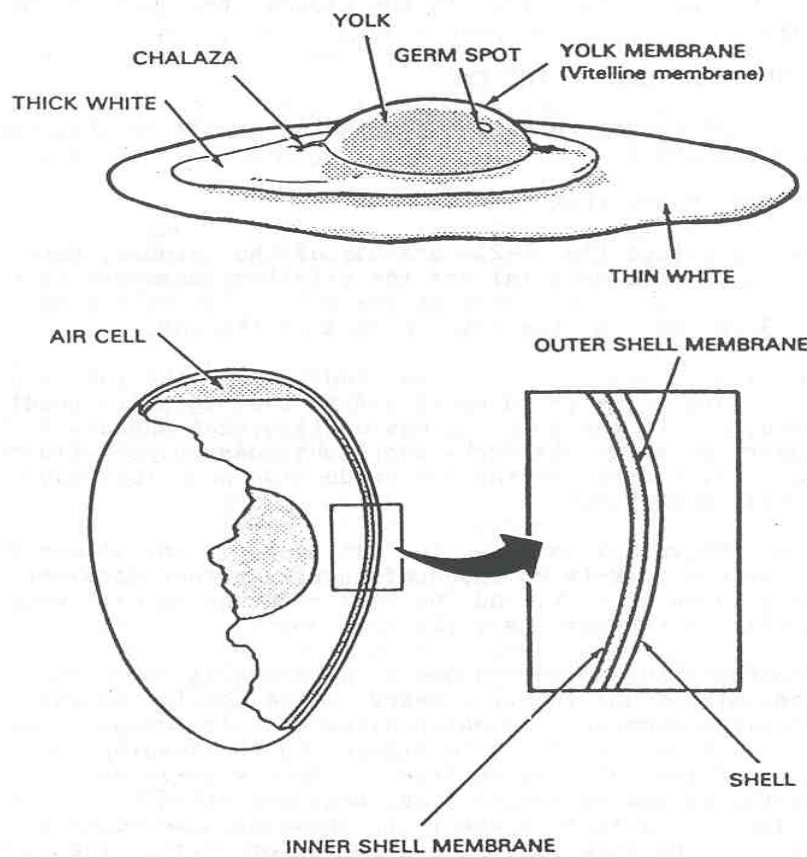

Figure 1-3. Structure of an egg.

b. **Oviduct.** At the time of embryonic development, the oviduct is a paired structure. As the chick matures, the right ovary and oviduct fail to develop, and diminish in size until they disappear by the time the hen reaches maturity. The left oviduct functions to complete the development of the egg and provides a channel to convey the yolk to the exterior. It also stores sperm cells prior to fertilization of the germ spot. The oviduct can be divided into five areas:

(1) Infundibulum. This is the funnel-shaped structure that receives the yolk after it is released from the ovary. Although the main function of the infundibulum is to pick up the yolk, it also serves as a reservoir for male sperm that, if present, fertilize the germ and set up embryonic growth.

(2) Magnum. When the yolk is released, peristalsis (wavelike movements) of the infundibulum conveys the yolk into the magnum, which is commonly referred to as the front, or anterior, portion of the oviduct. The front part of the magnum secretes a dense, plastic-like gel made up of threadlike strands. This gel is the chalaziferous layer. As the egg travels along the oviduct, it rotates, causing a rope-like twisting of the threads, which results in the chalaza in the completed egg. The chalaza holds the yolk in the center of the egg and ensures that the germ spot (germinal disc) remains up when the egg is being incubated. The dense, thick white (albumen) is secreted in the last part of the magnum, and the chalaza and thick white are interwoven to provide a firm support for the yolk.

(3) Isthmus. The isthmus is a constricted area of the oviduct through which the developing egg passes. In the isthmus, the inner and outer shell membranes are developed around the dense white. The outer shell membrane is the thickest and conforms to the shape of the egg. The shell membranes are formed before the thin white is secreted.

(4) Uterus. The uterus is a heavy-walled part of the oviduct and supplies the final complement of white and minerals (which pass through the shell membranes by osmotic pressure); then the shell, shell pigment, and cuticles are added.

(5) Vagina. This portion of the oviduct holds the completely formed egg, allowing the exterior shell to dry and become hard before the egg is released. The vagina is joined to the cloaca, the opening through which the egg is laid.

### **1-3. PHYSICAL STRUCTURE OF THE EGG**

The physical structure of the egg includes yolk, white, shell membranes, and the shell.

#### **1-4. FORMATION OF THE YOLK**

a. The yolk (see figure. 1-2) consists of the latebra, germinal disc, concentric rings of yolk material and the vitelline membrane (a colorless membrane) that surrounds and contains the yolk. The yolk constitutes approximately 31 percent of the total weight of the egg.

b. The yolk grows by the gradual addition of the yolk fluid. Fat-soluble dyes are transferred rapidly from the digestive tract to the bloodstream and then to the yolk. Occasionally, what appears to be concentric layers of alternate dark- and light-colored yolk fluid may be observed. However, modern feeding and production practices have reduced the frequency of this occurrence.

c. When the yolk is mature, the sac ruptures and allows the yolk to escape. Each mature yolk is composed of a germ spot or germinal disc, a fatty substance known as yolk, and the yolk membrane we call vitelline membrane and which surrounds the yolk.

d. The formation of an egg begins with ovulation, which is the release of the matured yolk (ovum) from the ovary. Each developing yolk is enclosed in a sac (vitelline membrane) in which blood vessels are distributed for the purpose of carrying yolk-building substances to the developing yolk. One particular area of the yolk sac is free of blood vessels and it is normally in this area, the stigma or suture line, that ovulation or release of the mature yolk takes place (see figure 1-1). However, the rupture of the yolk sac and release of the yolk sometimes occur at other than the stigma with the result that one or more blood vessels are ruptured. This causes blood spots to occur on the yolk or the white to become bloody.

e. Occasionally, reddish brown, brown, tan, or white spots commonly known as "meat spots" may be found in the egg. These meat spots may be either blood spots that have changed in color caused by chemical action or tissue sloughed off from the reproductive organs of the hen.

#### **1-5. FORMATION OF THE WHITE**

a. The white (see figures 1-2 and 1-3) consists of several layers of albumen that together constitute about 58 percent of the weight of the egg.

(1) The chalaziferous layer immediately surrounds the yolk and is continuous with the chalazae (pronounced kay-lay-za). This is a very firm but very thin layer of albumen. It makes up three percent of the total albumen.

(2) The inner, thin layer surrounds the chalaziferous layer and comprises about 21 percent of the white.

(3) The firm or thick layer of albumen provides an envelope or jacket which holds the inner, thin white and the yolk. It adheres to the shell membrane at each end of the egg. Approximately 55 percent of the white is firm albumen.

(4) The outer, thin layer lies just inside the shell membranes, except where the thick white is attached to the shell, and accounts for about 21 percent of the total albumen.

b. It is in the oviduct that the white, shell membranes, and shell are secreted.

(1) In the first part of the oviduct, which is the infundibulum, the yolk is engulfed and started on its way down the oviduct. The yolk moves through the infundibulum to the magnum in about 15 minutes.

(2) In the magnum area is secreted the thick white, which comprises approximately 55 percent of the albumen and practically all the protein in the albumen. The quality of the white is largely dependent on the amount of mucin secreted by this part of the oviduct.

(a) The albumen (see figure 1-2) secreted by the magnum is a homogeneous gel. The mucin (secreted as fibers) is responsible for the gel. The portion of the gel immediately adjacent to the yolk undergoes partial liquefaction before the egg leaves the magnum. The spiral movement of the developing egg as it passes through the oviduct causes the mucin fibers to draw together.

(b) From these strands, the chalaziferous layer and the chalazae are formed. The twisting and drawing together of these mucin strands tend to squeeze out thin albumen to form the inner, thin white. Thus, three layers of albumen are formed from the homogeneous gel as follows: (1) chalaziferous layer continuous with the chalazae, (2) the inner thin white, and (3) the thick white. The outer, thin white (4th layer) is added in the uterus through the shell membranes. The water and solids content of the white ultimately becomes equally distributed in the various layers of the white.

(c) The time required for the yolk to travel through the magnum is about 3 hours.

(3) In the isthmus, some water and mineral salts are added and the two shell membranes are deposited. The developing egg passes through this area in about 1 1/4 hours.

(4) In the uterus, the thin white, the hard shell, and the cuticle of the completed egg are formed. The thin white is secreted in the anterior portion of the uterus and is called "plumping" the egg. The posterior portion of the uterus deposits

calcium carbonate, a chemical derived from food containing oyster shells, mineral supplements, and limestone, to form the hard, outer shell. This shell is quite porous, containing 3000 to 8000 pores, with most of them in the large end. The cuticle, a waxy, mucous-like substance secreted by the uterus, forms a protective covering for the egg and prevents or inhibits the loss of moisture and gases. The developing egg spends about 21 hours in the uterus.

(5) Moving finally into the vagina, the fully formed egg enters the cloaca and the vent, and is laid. The entire time from ovulation to laying is usually slightly more than 24 hours. As the contents of the egg cool, immediately following laying, an air cell forms between the two shell membranes, usually at the large end of the egg. About 1/2 hour after a hen has laid an egg, she releases another yolk (ovulation), and it will likewise travel the length of the oviduct.

## **1-6. FORMATION OF THE SHELL MEMBRANES**

The shell membranes (see figure 1-3) are added as the partly formed egg enters the isthmus. The shell membranes are tough and fibrous and are composed chiefly of protein, similar in nature to that in hair and feathers. The inner membrane is thinner than the outer and together they are only about twenty-four ten-thousandths of an inch thick.

## **1-7. FORMATION OF THE SHELL**

a. The shell (see figure 1-3) is formed in the uterus. It constitutes approximately 11 percent of the egg and is composed of three layers:

(1) Mammillary or inner layer consisting of calcite crystals over the surface of the outer shell membrane in knoblike formations set perpendicular to the surface of the shell.

(2) Spongy layer consisting of small calcite crystals that are not arranged in any order except in the outer portion of the layer where crystals are set at right angles to the shell surface.

(3) Cuticle which is sometimes erroneously referred to as "bloom" and which is of a chemical composition similar to the shell membrane.

b. Calcium carbonate comprises about 94 percent of the dry shell. A hen may use as much as 47 percent of her skeletal calcium for egg shell formation.

c. Pores are formed through the spongy layer connecting some of the space between the knoblike mammilla with the surface. When the egg is laid, the pores are filled by the matrix material and covered by the cuticle.

d. The egg, as laid, normally has no air cell. It forms as the egg cools, usually in the large end of the egg, and develops between the shell membranes. The air cell is formed as a result of the different rates of contraction between the shell and its contents.

## **1-8. COMPOSITION OF THE EGG**

An average chicken egg weighs about 57 grams or 2 ounces. It is a very good source of high-quality protein and of certain minerals and vitamins. The protein, vitamin, and mineral contents of the albumen and yolk are described below.

### **a. Albumen.**

(1) The protein of egg is complete; it contains all of the indispensable amino acids in well-balanced proportions.

(2) The thick white is made up mainly of the proteins: ovomucin, ovoalbumen, conalbumen, ovoglobulin, and ovomucoid. Ovomucin gives structure to the thick white.

(3) The albumen contains some water-soluble B vitamins, especially riboflavin. The latter gives the greenish tint to the white.

(4) The thin white is composed mostly of proteins of the same kind as contained in the thick white with the exception of ovomucin.

### **b. Yolk.**

(1) The important yolk proteins are ovovitellin (about three- fourths of the yolk protein) and livetin.

(2) The fatty substances of the yolk are mostly glycerides (true fat), lecithin, and cholesterol.

(3) Yolk pigments (mostly xanthophyll) come from green plants and yellow corn that the birds eat.

(4) The yolk contains practically all of the known vitamins except vitamin C. The vitelline membrane is mostly protein similar to that of the shell membranes and is fairly permeable to water. The higher concentration of the solids of the yolk causes the yolk to increase in size and grow flabby by the inflow of water from the white as the egg ages.

(5) The yolk contains iron, phosphorus, sulphur, copper, potassium, sodium, magnesium, calcium, chlorine, and manganese, all of which are essential elements.

## 1-9. ABNORMALITIES IN EGGS

a. **Foreign Bodies.** Foreign bodies, such as pieces of straw, kernels of corn, or intestinal parasites, are occasionally found in eggs. The foreign material enters the cloaca and works up the reproductive tract (reverse peristalsis) until it encounters a descending yolk. Since it cannot bypass the yolk, it is forced downward and becomes enmeshed in the shell or its contents. Roundworm, usually found in the intestinal tract, can migrate from the cloaca into the oviduct where it may become included in an egg. Once foreign material is surrounded by the albumen of a forming egg, it becomes part of the egg and is covered by the shell membrane and shell.

### b. **Malfunction of the Reproductive Tract.**

(1) Multiple yolks. Sometimes multiple yolks, or an egg within an egg, develop. Basically, all anomalies of this type result from the same kind of process, a reverse movement of a yolk after it has progressed part way down the reproductive tract. For example, the yolk may move to the isthmus and then (for some reason) be forced back into the infundibulum where it encounters another yolk; the two then progress through the tract.

(2) Blood spots. Blood spots are caused by intrafollicular bleeding at the time of ovulation. The blood may adhere to the yolk membrane or be included in the albumen.

## Section II. PREPARING A CANDLING ROOM AND ASSEMBLING EGG INSPECTION EQUIPMENT

### 1-10. GENERAL

When shell eggs are examined during destination or surveillance inspection, a basic item of equipment is an egg candler, which is used for the candling process. Candling is a visual examination of an egg, in the shell, by use of an intense light. It permits viewing of the shell egg contents to determine individual egg quality. The candling process must be conducted in a dark area, either a candling booth or a candling room, with the candling light from the egg candler providing the only source of light. This permits the inspector to view eggs in the case, as well as to fully illuminate the shell egg to examine the egg interior for quality. A diagram of an egg candler is shown in figure 1-4.



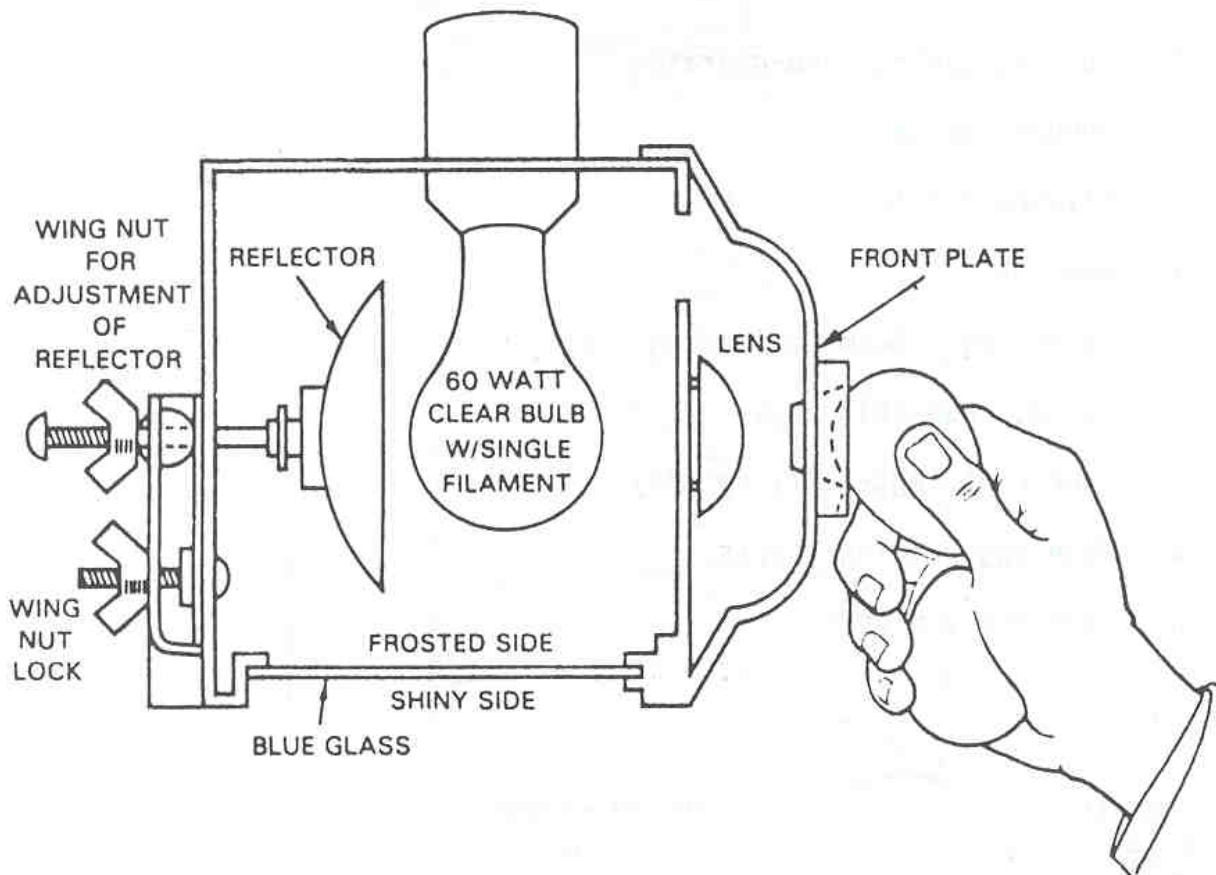

Figure 1-4. Egg candler.

### 1-11. EQUIPMENT FOR EGG INSPECTION

You, the veterinary food inspection specialist, must be familiar with the equipment used in inspection and see that it is in good condition so that there is no reason for controversy over your determinations. A standard veterinary egg inspection set includes:

- a. Case, veterinary egg inspection set.
- b. Thermometer, self-indicating, bimetallic dial, 5 1/2 inches (14 cm).
- c. Candler, egg, aluminum, 110 volts, AC-DC (figure 1-4).
- d. Plate, egg-testing, aluminum.
- e. Inking pad, rubber stamp, veterinary food inspection.

- f. Stamps, Department of Defense (DOD), PIA, and CIA, Medical Service.
- g. Rubber type set, numerical, food inspection stamps, veterinary, small.
- h. Cutter, cable, hand-operated.
- i. Opener, crate.
- j. Clipboard file.
- k. Padlock.
- l. Scale, egg, beam indicating (figure 1-5).
- m. Scale, case-weighing.
- n. Four empty egg-tallying trays.
- o. United States Department of Agriculture (USDA) egg-grading charts.
- p. Egg-candling bench.

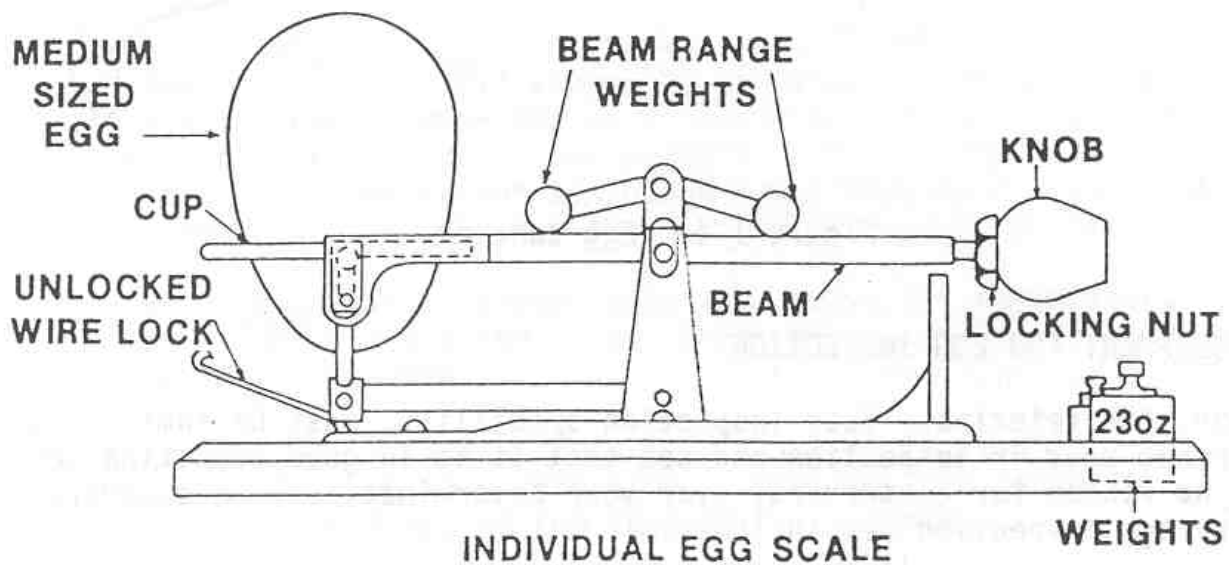

Figure 1-5. Beam indicating scale.

## 1-12. EGG INSPECTION ROOM OR BOOTH

a. **Room with Equipment Required.** An egg candling room (or booth) and equipment are normally available for your use; however, you must be able to prepare the inspection area and set up the egg candling equipment if none is readily available. An ideal candling booth is shown in figure 1-6.

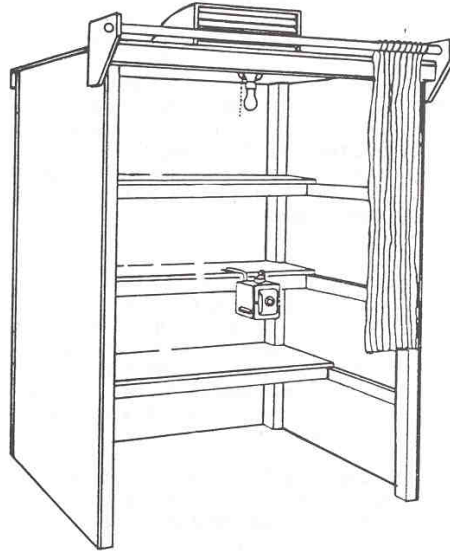

Figure 1-6. Egg candling booth.

b. **Ideal Inspection Room.** The ideal inspection room would be:

- (1) Six feet wide, 4 feet in depth, and 7 feet high.
- (2) Temperature of the room should be controlled between 40°F (4°C) and 50°F (10°C).
- (3) The room should have a separate light switch so as to control light. The room during candling must be as dark as possible with no cross beams of light between you and the candling light.
- (4) The room should include a candling bench, approximately 24 inches high, 24 inches wide, and 72 inches long, with adjacent switch to control room lights. Bench should have two shelves (figure 1-6).
- (5) The room should be able to accommodate other inspection equipment and allow you to move adequately.

(6) The room should have enough space for sample cases and for separation of cases already inspected.

(7) The room must have a container for disposing of waste materials.

(8) Egg grading charts should be attached to the wall over the egg bench. There are two egg grading charts prepared by the USDA and available from the Superintendent of Documents, Washington, DC. The two charts are "Illustration of the Interior Quality of Eggs" and "Illustration of US Standards for Quality of Individual Shell Eggs." You can use these charts as a guide when candling eggs.

### **1-13. EGG CANDLER**

a. **Setting Up the Candler.** The egg candler (figure 1-4) should be mounted on the candling bench so that it can be moved forward or backward, up or down, and so that it can be adjusted to your height. If the candling room does not contain a candling bench, the egg candler should be mounted on the chest used to store the egg inspection equipment. Before candling the eggs, you should adjust the candler so that you can stand erect with your elbows at right angles and avoid leaning.

b. **Cleaning and Checking the Candler.** The egg candler is disassembled in the cleaning and checking process. A series of procedures is followed using a screwdriver, replacement parts as necessary, and a clean cloth.

(1) Examine the electrical cord for frayed and/or bared wires. Check to see that the candler is unplugged before cleaning and checking.

(2) Remove the two front screws in order to remove the front plate (front cover).

(3) Check the opening in the front plate where the egg is held up for examination. It should be no larger than 13/16 inch (20 cm) and tapering to 5/8 inch (15 cm).

(4) Remove the lens. Check the lens for chips and cracks. If the lens is cracked or spotted, you must obtain another one.

(5) Remove and examine the glass plate at the base of the light bulb. The glass plate is normally frosted and blue in color. Dust the glass plate with a clean cloth and check it to make sure that it is not cracked or chipped. If it is cracked or chipped, you must obtain another one.

(6) Remove the light bulb. Be sure to use a clean cloth to remove and dust the light bulb. Do not touch the light bulb with your fingers or hand, as this will leave imprints on the bulb. The light bulb is not frosted and should be a 60-watt clear bulb with a single filament. Check to make sure that the light is not burned out.

(7) Remove the reflector. Check the reflector for cracks or spots (mottling). If it is cracked or spotted, you must obtain another one.

(8) Reassemble the candler.

(a) The light bulb should be positioned so that the filament of the bulb is parallel to the opening.

(b) The frosted glass plate at the base is positioned with the frosted side facing the interior of the candler.

(c) The lens should be positioned with the curved surface facing away from the light bulb.

(d) The front plate (or front cover) should be re-attached with two screws.

(e) The opening should be checked to make sure that a bumper of rubber, wood, or some similar material is present around the opening in the front plate. If there is no structure (bumper) to keep the egg from contacting the metal, you must obtain a bumper.

**c. Adjusting the Height and Focusing the Beam of Light.** To adjust the candler's height, loosen the wingnuts, slide the candler up or down, and retighten the wingnuts. The final position should allow the person who performs the candling to stand erect with the forearms extended forward from the waist. After you have adjusted the candler to its proper height, plug it in and turn it on. To focus the beam of light from the candler:

(1) Hold a sheet of white paper about 1 inch from the opening. With your free hand, loosen the bottom wing nut on the back of the candler.

(2) Adjust the top wing nut to rotate the reflector until you see a beam of light equal to the size of a half dollar on the white sheet of paper. The image should be sharp and crisp, without a double image.

(3) Upon getting a sharp, crisp, single image, the bottom wing nut is tightened.

## 1-14. INDIVIDUAL EGG SCALE

a. **Procedure to Check Scale Accuracy.** You must check the accuracy of the individual egg scale (beam indicating scale) (figure 1-5). You may use the following procedure:

- (1) Remove the egg scale from the kit and place the scale on a level table.
- (2) Release the wire lock.
- (3) Place the 20-ounce/dozen weight in the cup.
- (4) Position one beam range weight toward the cup and the other beam range weight toward the knob.
- (5) Unloosen locking nut and screw the counterbalance knob in or out until the scale is balanced.
- (6) Tighten the locking nut. (You may need to screw the knob in slightly as you tighten the nut in order to keep the scale balanced.)
- (7) Recheck the scale to ensure that it is balanced.
- (8) Flip the beam range weight positioned toward the cup so that both beam range weights are positioned toward the knob.
- (9) Replace the 20-ounce/dozen weight with the 23- ounce/dozen weight.
- (10) Scale should balance without any additional adjustment of the knob.
- (11) If scale does not balance, perform the procedure again. If the scale still does not balance, use another scale.
- (12) The test weights should be verified periodically using a gram scale.

b. **Alternative Procedure.** You may use the following equally valid procedure of checking the accuracy of the scale instead of the first procedure:

- (1) Balance the scale with a 23- ounce/dozen weight in the cup and with the beam range weights pointed in opposite directions.
- (2) Replace the 23- ounce/dozen weight with a 20- ounce/dozen weight and position both beam range weights toward the cup.

c. **Standard for Scale Balance.** Using either of the two methods above, the scale is balanced when the beam is at rest, the knob end of the beam does not touch the knob support, and the cup apparatus does not touch the platform.

d. **How to Weigh Small, Medium, or Large Eggs.** To weigh for large, medium, or small weight classes:

- (1) Set one beam range weight toward the knob and the other toward the cup.
- (2) Place the 20- ounce/dozen weight in the cup.
- (3) Balance using knob and nut.

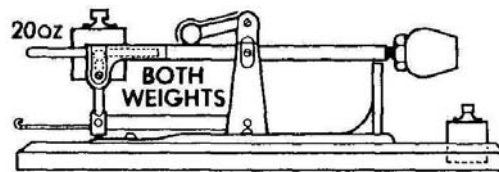

(4) To check scales, flip both beam range weights toward knob and put the 23- ounce/dozen weight in the cup.

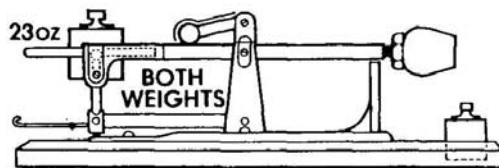

(5) To weigh for small eggs, flip both beam range weights toward the cup.

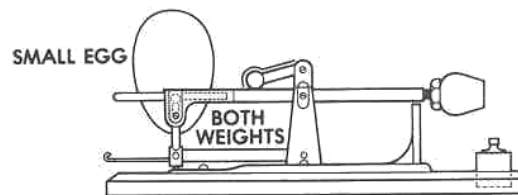

(6) To weigh for medium eggs, flip one beam range weight toward the cup and the other toward the knob.

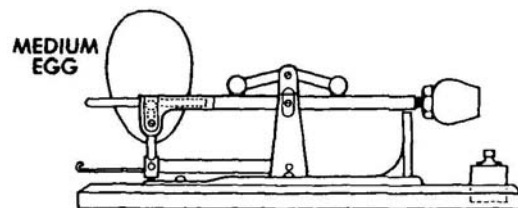

- (7) To weigh for large eggs, flip both beam range weights toward the knob.

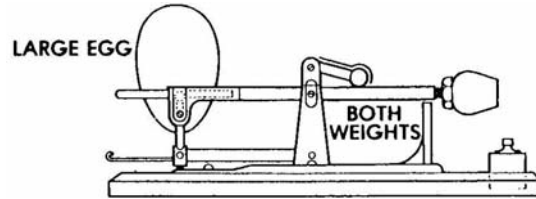

e. **How to Weigh Extra-Large Eggs.** To weigh for the extra-large weight class:

- (1) Set one beam range weight toward the knob and the other toward the cup.
- (2) Place 23- ounce/dozen weight in the cup.
- (3) Balance using knob and nut.

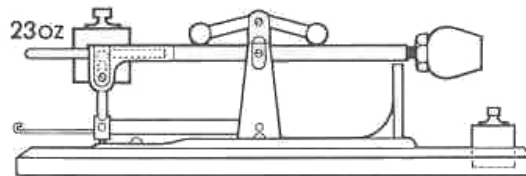

- (4) To check scales, Arrangement of flip both beam range weights toward basket and put 20- ounce/dozen weight in the cup.

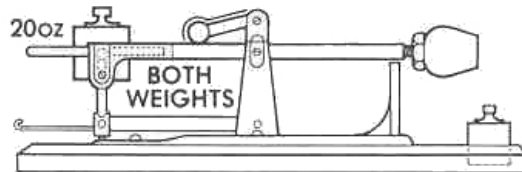

- (5) To weigh, flip both range weights toward the knob.

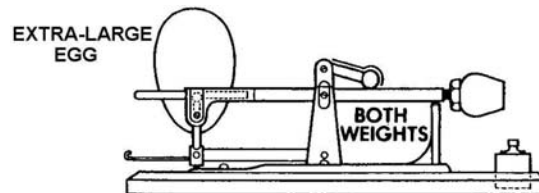



f. **How to Weigh Jumbo Eggs.** To weigh for jumbo weight class:

- (1) Set both beam range weights toward the cup.
- (2) Place the 23- ounce/dozen weight in the cup.
- (3) Balance using knob and nut.

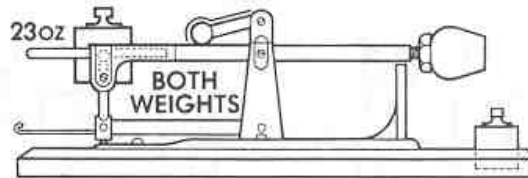

- (4) To weigh, flip both range weights toward the knob.

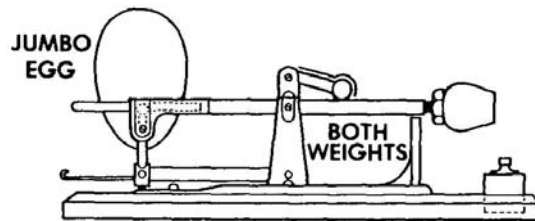

## 1-15. ARRANGEMENT OF EQUIPMENT

To candle eggs efficiently, the equipment must be conveniently arranged. (See figure 1-7.) See Lesson 3 for definition of terms and further information.

- a. Place empty egg tallying tray in a convenient location (often to the left of the candler). This tray will be used for grade A Quality eggs only. See figure 1-8.
- b. Place egg breakout plate in a convenient location (often to the immediate right of the candler). See figure 1-8. The plate should be clean and is used to break out eggs to determine quality and/or to verify suspected loss. The plate must be thoroughly cleaned between breakings.
- c. Place two empty egg tallying trays to the right of the breakout plate. The two empty trays will be used for tallying eggs of less than grade A Quality. See Lesson 4 for a suggested method of setting up tallying trays.
- d. Place individual egg scale on shelf above candler.
- e. Place sample eggs, withdrawn from the case or cases, beneath candler.

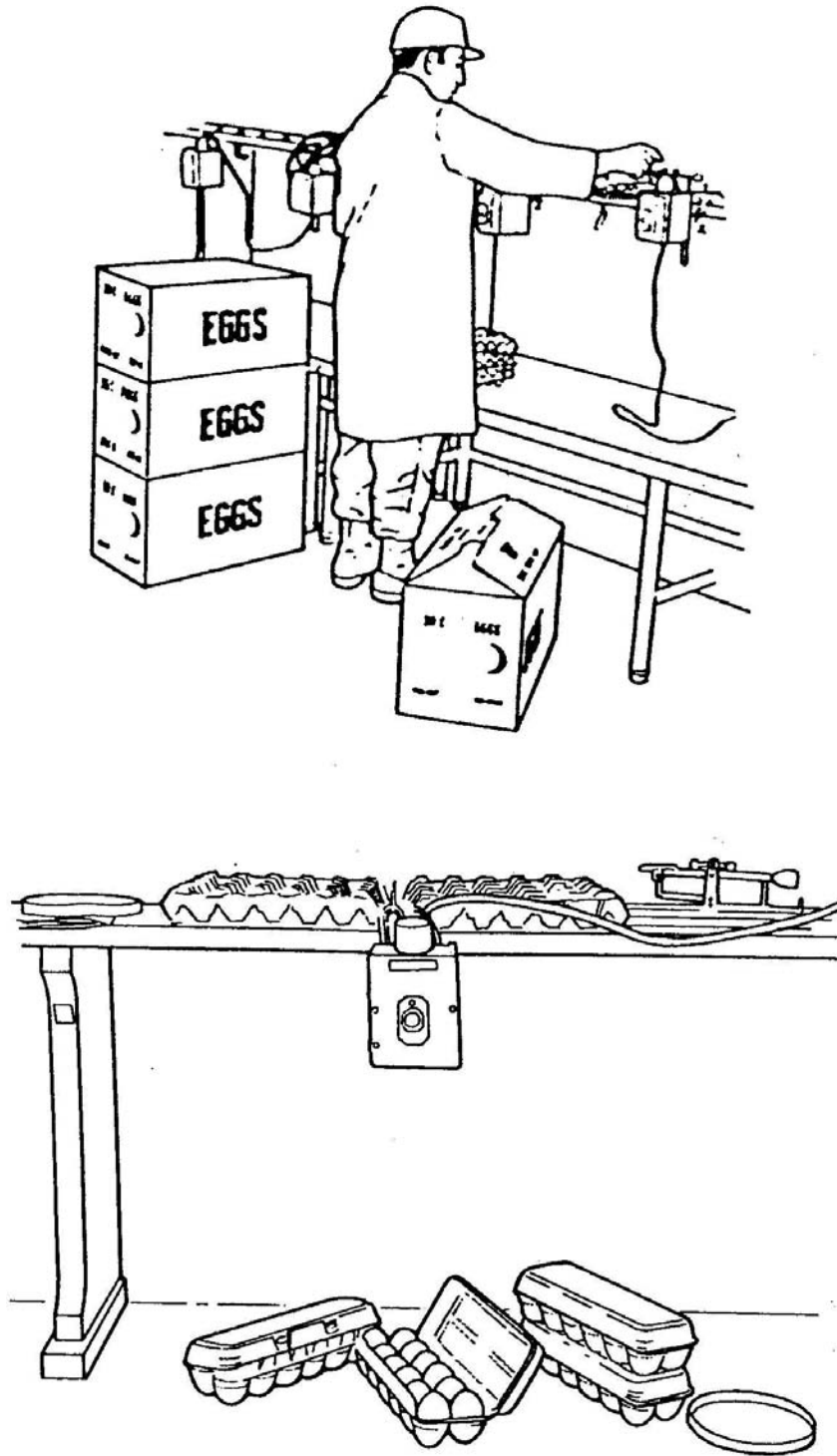

Figure 1-7. Arrangement of egg candling equipment.

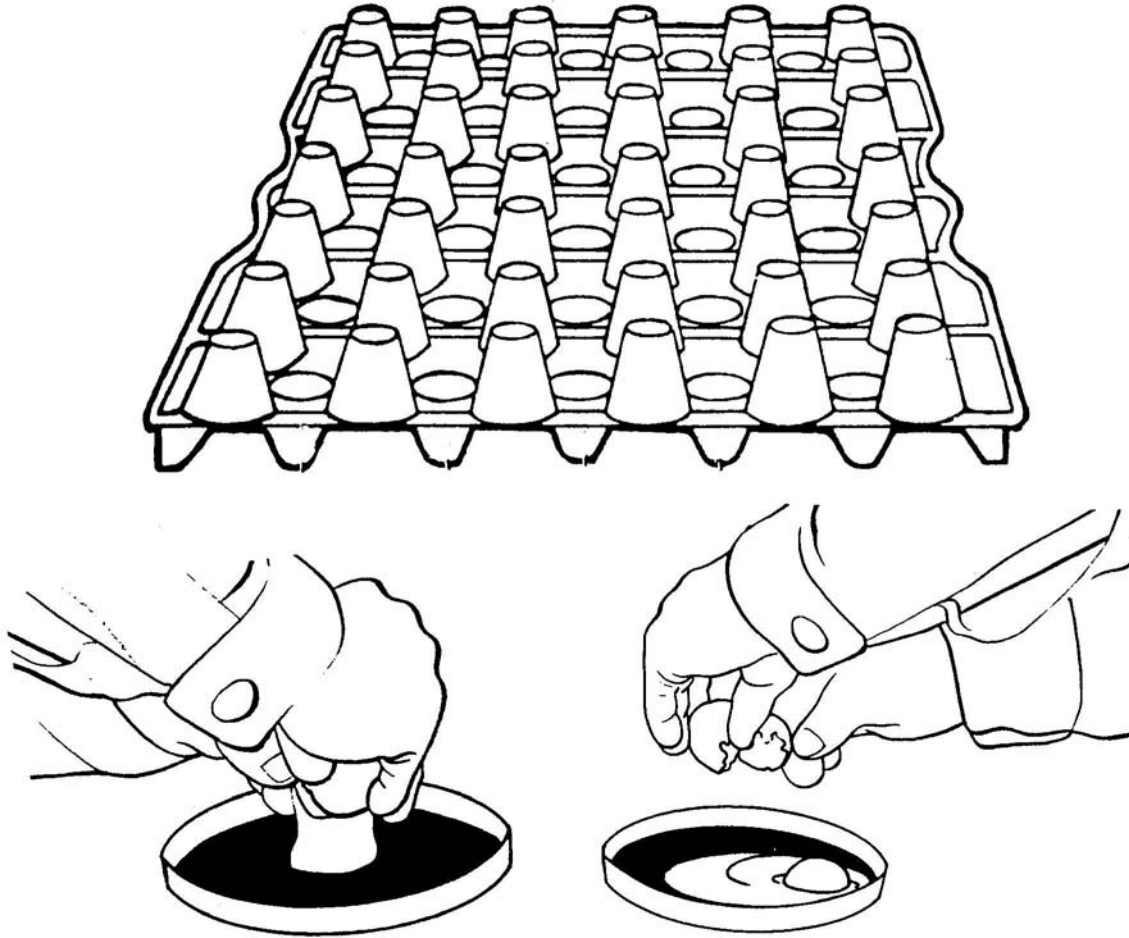

Figure 1-8. Egg tallying tray and breakout plate.

**Continue with Exercises**

## EXERCISES, LESSON 1

**INSTRUCTIONS:** The following exercises are to be answered by marking the lettered response that best answers the question or best completes the incomplete statement or by writing the answer in the space provided.

After you have completed all the exercises, turn to "Solutions to Exercises" at the end of the lesson and check your answers.

1. The physical structure of an egg consists of the:
  - a. Shell, albumen, germinal disc, and the white.
  - b. White, yolk, shell membranes, and the shell.
  - c. Yolk, shell membranes, latebra, and the oviduct.
  - d. Ovary, oviduct, albumen, and the shell.
  
2. Formation of an egg begins with:
  - a. Formation of the stigma or suture line.
  - b. Secretion of gel from the germinal disc.
  - c. Ovulation or release of a mature yolk.
  - d. Fertilization of the vitelline membrane.
  
3. The air cell in the large end of the egg is normally formed:
  - a. During the process in which the albumen is formed.
  - b. As the egg cools after it has been laid.
  - c. Within the ovary when the vitelline membrane ruptures.
  - d. When the egg passes through the isthmus.

4. The egg abnormality, "blood (meat) spots," is caused by:
- a. Rupture of one or more blood vessels in the yolk follicle at time of ovulation.
  - b. Tissue sloughed off of the reproductive organs on the hen.
  - c. Blood spots that have changed in color due to chemical action.
  - d. The egg being prematurely laid.
5. During the formation of the egg, the two shell membranes are deposited in the:
- a. Uterus.
  - b. Vagina.
  - c. Magnum.
  - d. Isthmus.
6. The egg shell is composed of three layers. They are:
- a. \_\_\_\_\_
  - b. \_\_\_\_\_
  - c. \_\_\_\_\_
7. The reproductive system of a hen consists of the \_\_\_\_\_ and \_\_\_\_\_

8. The oviduct of the hen is divided into five areas. The five areas are:

- a. \_\_\_\_\_
- b. \_\_\_\_\_
- c. \_\_\_\_\_
- d. \_\_\_\_\_
- e. \_\_\_\_\_

**Special Instructions for Exercises 9 Through 16.**

SITUATION: You are inspecting a shipment of eggs at your inspection station. You must prepare the egg inspection room and assemble and set up the egg inspection equipment.

- 9. The ideal temperature of the egg inspection room should be between \_\_\_\_\_ and \_\_\_\_\_.
- 10. The room should include a candling bench, approximately \_\_\_\_\_ inches high, \_\_\_\_\_ inches wide, and \_\_\_\_\_ inches long.
- 11. Egg grading charts should be attached to the wall of the egg inspection room over the \_\_\_\_\_.
- 12. The egg candler should be mounted on the candling bench and adjusted so that you, the veterinary food inspection specialist, can stand erect with your elbows at \_\_\_\_\_ and \_\_\_\_\_.
- 13. The glass at the base of the egg candler should be removed and examined for \_\_\_\_\_ or \_\_\_\_\_. This glass is normally \_\_\_\_\_ and \_\_\_\_\_ in color.
- 14. The light bulb in the egg candler should be a \_\_\_\_\_-watt \_\_\_\_\_ bulb with a single filament.

15. The frosted glass at the base of the egg candler is placed in the candler with the frosted side \_\_\_\_\_ the interior of the candler.
16. The beam of light from the egg candler should be adjusted so that the image is \_\_\_\_\_ and \_\_\_\_\_, without a double image.
17. When using the individual egg scale to weigh medium eggs, you must place the beam range weights so that one beam range weight is toward the \_\_\_\_\_ and the other is toward the \_\_\_\_\_.
18. When using the individual egg scale to weigh small eggs, you must place the beam range weights so that both beam range weights are toward the \_\_\_\_\_.

**Check Your Answers on Next Page**

## SOLUTIONS TO EXERCISES, LESSON 1

1. b (para 1-3)
2. c (para 1-4d)
3. b. (para 1-5b(5))
4. a, b, and c (paras 1-4e and 1-9b(2))
5. d. (paras 1-5b(3) and 1-6)
6. Mamillary or inner layer (para 7a(1))  
Spongy layer. (para 1-7a(2))  
Cuticle. (para 1-7a(3))
7. Ovary, oviduct. (para 1-2)
8. Infundibulum. (para 1-2b(1))  
Magnum. (para 1-2b(2))  
Isthmus. (para 1-2b(3))  
Uterus. (para 1-2b(4))  
Vagina. (para 1-2b(5))
9. 40EF (4EC) and 50EF (10EC). (para 1-12b(2))
10. 24, 24, 72. (para 1-12b(4))
11. Egg bench. (para 1-12b(8))
12. Right angles, avoid leaning. (para 1-13a)
13. Chips, cracks; frosted, blue. (para 1-13b(5))
14. 60, clear. (para 1-13b(6))
15. Facing. (para 1-13b(8)(b))
16. Sharp, crisp. (para 1-13c(2))
17. Cup; knob. (para 1-14d(6))
18. Cup. (para 1-14d(5))

End of Lesson 1



## **LESSON ASSIGNMENT**

### **LESSON 2**

Destination Inspection of Shell Eggs.

### **LESSON ASSIGNMENT**

Paragraphs 2-1 through 2-17.

### **LESSON OBJECTIVES**

After completing this lesson, you should be able to:

- 2-1. Identify correct procedures for the selection of samples for egg inspection.
- 2-2. Identify destination inspection procedures for shell eggs.
- 2-3. Identify correct procedures for determining and recording the actual net weight of a case of shell eggs.

### **SUGGESTION**

After studying the assignment, complete the exercises of this lesson. These exercises will help you to achieve the lesson objectives.

## LESSON 2

### DESTINATION INSPECTION OF SHELL EGGS

#### Section I. INTRODUCTION

##### 2-1. GENERAL

a. Acceptance inspection of shell eggs at destination will be for identity, count, and condition. In addition, verification of origin grade and all other contract requirements will be performed.

(1) Destination inspections are classes 4 and 8.

(2) These inspections are done when shell eggs are delivered to the military services.

(3) This is the final inspection before ownership is transferred from the contractor to the Government.

b. The grade verification requires that a sufficient number of samples be candled at destination to verify origin inspection. Certain changes occur while handling and shipping eggs that can result in downgrading. However, to compensate for these unavoidable changes, eggs at destination may be accepted even with certain variations. These variations are listed in the USDA "Regulations Governing the Grading of Shell Eggs and US Standards, Grades, and Weight Classes for Shell Eggs."

##### 2-2. INSPECTION DATA PACKET

a. The inspection data packet (IDP) includes the documents needed to inspect the shell eggs. Documents normally included in the inspection data packet are the contract, solicitation, technical data sheet, subsistence master solicitation, specification, USDA Regulations, and USDA certificates. See Subcourse MD0705, Inspection Documents.

b. The inspection data packet will be used to determine the product to be delivered; product requirements, container size, container count, packing, packaging, and marking requirements; and any special requirements.

##### 2-3. INSPECTION RESPONSIBILITY

a. **Origin Inspection.** The egg production pattern and marketing system in the United States are such that interstate trading and shipment occur constantly and in large volume. This situation creates a need for uniform standards for eggs throughout the United States. To aid in this situation, officials of the USDA, state inspection services, and industry leaders have for a number of years been encouraging the use of

USDA "Regulations Governing the Grading of Shell Eggs and US Standards, Grades, and Weight Classes for Shell Eggs." These regulations have been developed as required by the Agricultural Marketing Act of 1946. The voluntary USDA shell egg grading program operates under these regulations. The voluntary program provides for interested parties a national grading service based on official US standards, grades, and weight classes, and minimum sanitary and operating requirements. The costs involved in furnishing this grading program are paid by the user of the service.

(1) The grading program and the regulations establish a basis for quality and price relationships and enable more orderly marketing. Consumers can purchase officially graded products with the confidence of receiving quality in accordance with the official identification.

(2) Certain plants are listed in the USDA document "List of Plants Operating Under USDA Poultry and Egg Grading and Egg Products Inspection Programs." These officially approved plants receive voluntary grading and inspection services on poultry, shell eggs, rabbits, and egg products under the Agricultural Marketing Act of 1946, as amended. They also receive mandatory egg products inspection under the Egg Products Inspection.

b. **Destination Inspection.** On each shipment received, destination inspection is performed by Veterinary Service personnel. The inspector compares information from the inspection data packet with the information on the USDA Poultry Products Grading Certificate.

## 2-4. BASIS OF GRADES

The grades of shell eggs, the weight classes, and the requirements for each grade and weight, are cited in the USDA "Regulations Governing the Grading of Shell Eggs and US Standards, Grades, and Weight Classes for Shell Eggs." The specification for shell eggs establishes the packaging, packing, and marking requirements and cites the portion of the USDA publication that applies to military procurement. The Defense Personnel Support Center (DPSC) issues clauses that implement both the specification and the regulations. Shell eggs are separated by quality and weight and are classified as follows:

a. **Grades.** Grades for individual egg quality are AA Quality, A Quality, B Quality, B\* Quality, Dirty, Check, Leaker, and Loss.

b. **Weight Classes.** Weight classes (sizes) of eggs are jumbo, extra large, large, medium, and small.

## Section II. SAMPLING DATA

### 2-5. DETERMINING LOT SIZE

How the lot size is determined is dependent on the number of dozens of eggs being delivered. This information is extracted from the IDP. The IDP usually stipulates either wholesale grade troop issue or consumer grade resale shell eggs.

a. Wholesale grade shell eggs are normally used for troop issue feeding and come 30 dozen to a case. The shipping container is divided into two compartments with each compartment containing six layers (see figure 2-1), with one tray per layer. There are 30 eggs on each tray. Each compartment will have seven trays, six will contain eggs and the top will be empty and provide protection. An egg tray is illustrated in figure 2-2.

b. Consumer grade shell eggs, normally used for resale in commissaries, come in 15, 18, 24, or 30 cartons of eggs per container. The eggs are packed one dozen per carton.

c. The lot size is always expressed in cases (a case is 30 dozen or 360 eggs) except when temperature requirements are being given. When temperature requirements are stated, the lot size is expressed in terms of shipping containers.

(1) To convert the number of eggs (in dozens) to cases, divide 30 into the total number of dozens of eggs being inspected. See figure 2-3 for the multiplication factors provided in subsection 218.8 of DPSC Manual 4155.6.

(2) To convert the number of eggs (in dozens) to shipping containers, divide by number of dozens per shipping container.

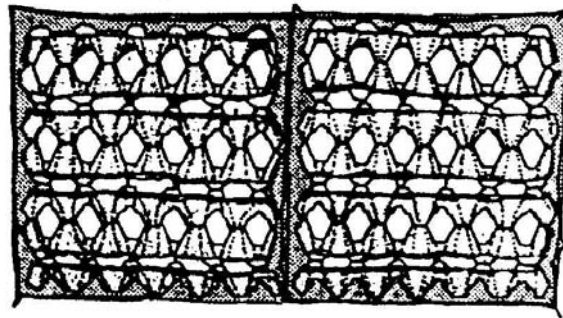

Each container is divided onto two compartments by a divider. Each compartment contains six trays, one tray per layer.

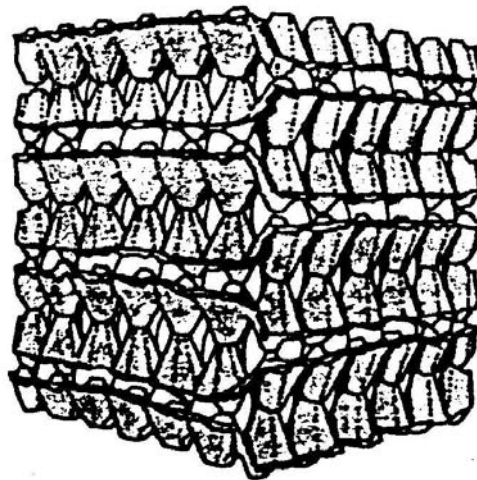
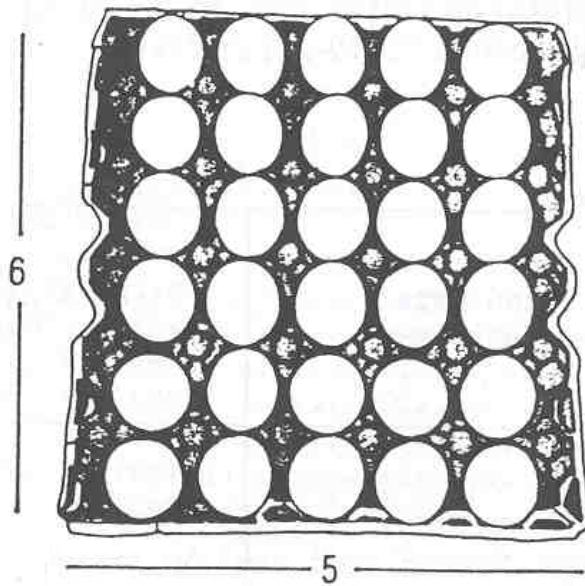

Figure 2-1. Case of wholesale grade shell eggs.



**Each tray holds 30 eggs, five across one side and six across the other side.**

Figure 2-2. Egg tray, wholesale grade shell eggs.

## 2-6. DETERMINING SAMPLE SIZE

See Subcourse MD0707, Statistical Sampling I, for the procedure to determine sample size.

a. The sample size for internal temperature examination will be expressed in shipping containers. The lot size will be the number of shipping containers. Inspection Level S-2 is used.

b. The sample unit for verification of grade and weight of individual eggs is 100 shell eggs from each sample case. As we have seen, a case is defined as 30 dozen eggs. When eggs are packed in other than 30-dozen cases, the appropriate multiplication factor is used to calculate the effective number of cases, the equivalent to 30-dozen cases. See figure 2-3. This furnishes the lot size.

Type Pack Number of Dozen Eggs Per Shipping Container	Multiplication Factor
12	.4
15	.5
16	.533
18	.6
24	.8
25	.833
40	1.33

Figure 2-3. The multiplication factors or 30 dozen equivalent shipping cases.

c. The sample size for initial destination is specified in the table in the DPSC Manual 4155.6, Subsection 218.8. See figure 2-4.

LOT SIZE (Number of "30-Dozen Cases" or Equivalent "30-Dozen Cases")	SAMPLE SIZE
1-50	1
51-100	2
101-200	3
201-300	4
More than 300	5

Figure 2-4. Sample size table, DPSC Manual, Subsection 218.8.

d. When a nonconformance is determined and additional samples are to be examined, then the sample size for candling and net weight are taken from the table in the USDA "Regulations Governing the Grading of Shell Eggs and US Standards, Grades, and Weight Classes for Shell Eggs." See figure 2-5.

MINIMUM NUMBER OF CASES COMPRISING A REPRESENTATIVE SAMPLE	
<u>Cases in Lot:</u>	<u>Cases in sample</u>
1 case *	1
2 to 10, inclusive	2
11 to 25, inclusive	3
26 to 50, inclusive	4
51 to 100, inclusive	5
101 to 200, inclusive	8
201 to 300, inclusive	11
301 to 400, inclusive	13
401 to 500, inclusive	14
501 to 600, inclusive **	16

\* For lots which consist of less than 1 case, a minimum of 50 eggs must be examined. If the lot consists of less than 50 eggs, all eggs must be examined.

\*\* For each additional cases, or fraction thereof, in excess of 600 cases, one additional case must be included in the sample.

Figure 2-5. Sample size Table, USDA regulation.

**2-7. SELECTING SAMPLE CASES/SHIPPING CONTAINERS**

a. When selecting samples, select the number of cases/shipping containers equal to the sample size.

b. When selecting samples, indicate which sample shipping containers are to be used for taking internal temperature.

c. Before selecting cases for sampling, a predetermined pattern must be established to ensure randomness of selection. The best way to ensure that the sample cases drawn are representative of the entire shipment is to assign a number to each case in a lot, then follow a procedure similar to the one described in Military Handbook 53 to choose the sample cases. The inspector should identify the samples by applying special markings at the time of their selection to avoid the possibility of being presented the wrong cases as a result of the time lag between selection of the sample cases and their removal from the lot to the candling room. Each case should be numbered consecutively, the case number circled, and the case initialed by the inspector. An indelible wax pencil or crayon can be used for this. The DOD stamps must not be used because, if the lot is provisionally rejected, the impressions would then have to be removed or obliterated.



### Section III. IDENTITY INSPECTION

#### 2-8. IDENTITY

Inspection for identity is a determination that the product is that specified in the contract, and, if inspected at origin, is the same product. The inspection may be accomplished by survey of inspection stamps, inspection reports, case codes, car numbers (designating transport vehicles, such as railcars or trucks), invoices, manifests, and labels.

#### 2-9. UNITED STATES DEPARTMENT OF AGRICULTURE GRADING CERTIFICATE AND OFFICIAL GRADEMARK

a. For consumer grade shell eggs, a USDA Poultry Products Grading Certificate (figure 2-7) must accompany each shipment except when the official grademark of USDA (USDA Grade Shield) is on the individual cartons (figure 2-6).

b. If the individual cartons of consumer grade shell eggs are grademarked with the USDA shield, then a USDA grademark will also appear on the packing (cases) (see figure 2-7).

c. For troop issue, a USDA Poultry Products Grading Certificate must accompany every shipment (figure 2-8).



Figure 2-6. United States Department of Agriculture official grademark for cartons packed under A Quality control.



Figure 2-7. USDA grademark.



d. Inspection procedures for procurement inspections at destination start with a general series of actions taken prior to the selection of samples.

- (1) It must be determined if the shipment is authorized.
- (2) It must be determined if the shipment is early or late.
- (3) It must be verified that a USDA inspection was performed.
- (4) It must be determined if the product is from an approved source.
- (5) Nonconformances notes must be reported to the CQAF before developing a sample plan or selecting samples.

## 2-10. IDENTITY REQUIREMENTS

a. There are two conditions of shell eggs: Condition 1 and Condition 2.

(1) Condition 1. Condition 1 refers to fresh eggs that are of recent production. They must not have been held in excess of 30 days. They must have been kept under acceptable conditions of temperature and humidity.

(2) Condition 2. Condition 2 refers to fresh shell-protected eggs. These are eggs meeting the requirements for Condition 1 fresh eggs. However, they have been properly treated by oils or other processing fluids to seal the pores and to protect the quality of the egg. The oils or processing fluids must not impart color, flavor, or odor to the egg.

b. There are two groupings of eggs: wholesale and consumer.

(1) Wholesale Grades. Wholesale grade shell eggs are normally packed 30 dozen per case and are utilized for troop issue.

(2) Consumer Grade. Consumer grades are Fresh, Fancy Quality, AA, A, and B. These are normally packed 24 dozen per case or 15 dozen per wire basket. These eggs are in one-dozen cartons and are utilized for resale.

## 2-11. IDENTITY INSPECTION

To perform identity inspection, you must do the following.

a. **Review the Requirements.** Using the inspection data packet, determine identity requirements and packaging, packing, and marking requirements. See the lesson in Subcourse MD0705, Inspection Documents, on extracting information from a DLA/DPSC inspection data packet.

**b. Inspect Packaging, Packing, and Marking.** Check to be sure that the product received is the same as that specified in the inspection data packet.

(1) Inspect the packaging, packing, and marking. Compare them with the packaging, packing, and marking requirements.

(2) Determine if an inspection was performed by the USDA. If inspection was done by the USDA, the containers will be stamped by the USDA. Case markings will indicate egg size and may give condition (1 or 2).

(3) Unless otherwise specified, eggs must be packed in new corrugated or solid fiberboard, commercial, 15-dozen or 30-dozen egg cases. The tops of fiberboard cases must be effectively sealed with adhesive, staples, or sealing strips. Alternatively, when specified, the eggs may be packed in good used cases and packing materials or a combination of new and good used materials. Eggs packaged in cartons must be packed in the container specified, except that interior packing may not be specified.

(4) Next, check the packaging. Egg trays must be new and made from materials that do not impart odors or flavor to the egg. If cartons are specified, they must be new.

(5) For consumer grade shell eggs, the date of pack will be printed on each carton. Julian date or "in the clear" form will be acceptable.

**c. Inspect Product.** Look at the container and product and determine whether the eggs are Condition 1 or 2 and whether the eggs are consumer or wholesale grade. In order to help determine whether Condition 2 eggs are being received, you (the inspector) may feel the eggs for evidence of oil.

## **Section IV. CONDITION INSPECTION**

### **2-12. CONDITION INSPECTION**

For condition inspection, you will inspect the eggs to determine that they are in the condition required by the contract, that the product is at the required temperature, and that the packaging (unit container) and packing (shipping container) are in such condition as to protect the product during storage and distribution. Using the sample cases selected for determining identity, you must:

**a. Inspect Conveyance.** Inspect the conveyance in which the shipment arrived by using procedures learned in Subcourse MD0694, Basic Food Inspection Procedures, Lesson 5.

b. **Inspect Shipping Cases.** Inspect the shipping cases to ensure that the packing and packaging are adequate to protect the product during storage and distribution. The shipping cases will be free of tears, crushed sides or corners, stains, or foreign material.

c. **Determine Product Age.** Determine the age of the product using procedures learned in Subcourse MD0694, Basic Food Inspection Procedures, Lesson 6, and compare actual age with age requirements.

d. **Verify Temperature of Conveyance.** Step "a" above indicated that the conveyance should be inspected. See Subcourse MD0694, Basic Food Inspection Procedures, Lesson 4, for measurement of product temperature. Temperature requirements for conveyances are found in the inspection data packet.

e. **Verify Temperature of Shell Eggs.**

(1) Temperature requirements for shell eggs are found in the inspection data packet. Current temperature requirements state that, at time of delivery, fresh eggs that are not more than 15 days old must have a case-average internal egg temperature no higher than 60°F (16°C) with no individual case having an internal egg temperature exceeding 65°F (18°C).

(2) You should take the internal temperature of at least one egg, and more if necessary, from each of the sample cases.

(3) Use the following method to determine internal temperature of shell eggs in tray packs (wholesale grade shell eggs):

(a) Choose an egg from the center area of the center tray of the compartment. This tray is NOT used for determining net weight. And the tray is NOT used for candling.

(b) Using one empty tray, place egg in tray with small end down.

(c) Take bimetallic (baby dial) thermometer, hold thermometer firmly in one hand, and place the point of the thermometer on the center part of the upright egg. Using two fingers from the other hand, tap the thermometer gently into the egg so that the egg encloses the sensing portion of thermometer.

(d) After five minutes, remove the thermometer and record the temperature. On each sample case drawn, an internal temperature will be taken using above procedures.

(e) Add up all temperatures taken from samples and determine average temperature.

(4) Use the following method to determine internal temperature of shell eggs in cartons (consumer grade shell eggs):

(a) If the shipping container contains more than 15 cartons per container, choose cartons located toward the center of the container that are not part of the net weight sample.

(b) If the container contains 15 or less cartons, choose a carton toward the center of the container which is not part of the 100-egg classification sample.

(c) Once a carton has been selected, choose an egg toward the center of the carton for internal temperature inspection.

(d) Using an empty egg carton, place egg in carton with small end down.

(e) Proceed to take temperature as was done for eggs in egg trays ((3)(c)-(e) above).

(5) Use the following method to determine case temperature:

(a) Place bimetallic (baby dial) thermometer between the second and the third filler, or insert the thermometer into the third filler at the end of the case not examined for quality.

(b) Leave thermometer there with top fillers in place.

(c) After five minutes, remove thermometer and record temperature.

f. **Determine Grade of the Lot.** The candling room is prepared and egg inspection equipment assembled as taught in Lesson 1 of this subcourse. The eggs are then classified (see Lesson 3 of this subcourse).

## **2-13. WEIGHT CLASSES FOR SHELL EGGS**

There are six weights and sizes of shell eggs; however, the military usually procures only large and medium sizes. The weight classes for consumer grade shell eggs, as found in the USDA regulations, are indicated in figure 2-9. The weight classes for wholesale grade shell eggs, as found in the USDA regulations, are indicated in figure 2-10.

Size or Weight Class	Minimum Net Weight Per Dozen	Minimum Net Weight Per 30 Dozen	Minimum Net Weight for Individual Eggs at Rate per Dozen
	Ounces	Pounds	Ounces
Jumbo . . .	30	56	29
Extra Large.	27	50 1/2	26
Large . . .	24	45	23
Medium . . .	21	39 1/2	20
Small. . . .	18	34	17
Peewee . . .	15	28	--

Figure 2-9. United States weight classes for consumer grades for shell eggs.

Weight Classes	Average Net Weight on Lot Basis 30-Dozen Case	Minimum Net Weight Individual 30-Dozen Case	Minimum Net Weight of Individual Eggs at Rate Per Dozen	Weight Version Tolerance for Not More Than 10 Percent, by Count, of Individual Eggs	
	Pounds	Pounds	Ounces	Under	But Not Under
Extra Large	50.5	50	26	26	24 ozs
Large. . .	45	44	23	23	21 ozs
Medium . .	39.5	39	20	20	18 ozs
Small. . .	34	None	None	None	

Figure 2-10. United States weight classes for wholesale grades for shell eggs.

## 2-14. SELECTING SAMPLES FOR DETERMINING NET WEIGHT

a. For consumer grade shell eggs, select 15 cartons of eggs from each sample container by using a predetermined sampling pattern. Since the number and arrangement of cartons within shipping containers may vary from vendor to vendor, no definite selection pattern may be given. If the shipping container contains only 15 cartons, select all of the cartons for the sample.

**NOTE:** You should note the odor coming from the case and packing material immediately upon opening the sample shipping containers. Off-odors (especially musty odors) should be noted.

b. For wholesale grade shell eggs, select either a whole case or half a case of eggs, depending on which method of weighing is to be used. Predetermine a sampling pattern before sampling. If only a half-case of eggs is to be weighed, determine in a random manner whether the marked and/or unmarked end of the first sample of the container is to be used. Alternate compartments on succeeding sample containers must be used. (Additional information on selecting samples is provided in Lesson 4 of this subcourse.)

## **2-15. DETERMINING ACTUAL NET WEIGHT OF A CASE OF SHELL EGGS**

You must determine that the actual weight of a case of shell eggs is as specified in the inspection data packet. You are not responsible for counting the number of units delivered. This is done by an accountable individual.

a. **Test Accuracy of Scales.** For additional information, see Subcourse MD0704, Inspection Records and Reports.

(1) Regular platform scales are normally used for weighing. However, a smaller case-weighing scale, included in the egg inspection kit, may be used if the platform scales are not available. Platform scales are preferred since the case-weighing scales can not be sealed.

(2) When case-weighing scales are used, test their accuracy with the following procedure:

(a) Turn the adjustment knob (usually located at the foot of the scales) so that the dial is set at zero.

(b) Place test weight(s) on the scale (20-25 pound weight is suggested).

(c) If scales are off by more than 1/4 pound, turn the adjustment knob until the desired reading is obtained.

b. **Determine Actual Net Weight of Consumer Grade Shell Eggs.**

(1) Remove a 15-dozen-egg sample from the container.



(2) Weigh the 15-dozen-egg sample in cartons, on a scale, to the nearest 1/4 pound. For review of the task, see Subcourse MD0704, Inspection Records and Reports. Do not weigh cartons one at a time. This may introduce too much error, especially when using case-weighing scales. If a carton has one or more eggs missing from the carton, do not replace the missing eggs.

(3) Determine the tare weight of the half-cases. To review how this is done, see Subcourse MD0704, Lesson 3. If the tare weight must be established, you must weigh no less than 15 empty cartons.

(4) Subtract the tare weight from the gross weight to obtain the net weight of the sample (half-case).

(5) Multiply the net weight of the sample (half-case) by two in order to obtain the actual net weight of the case (figure 2-11).

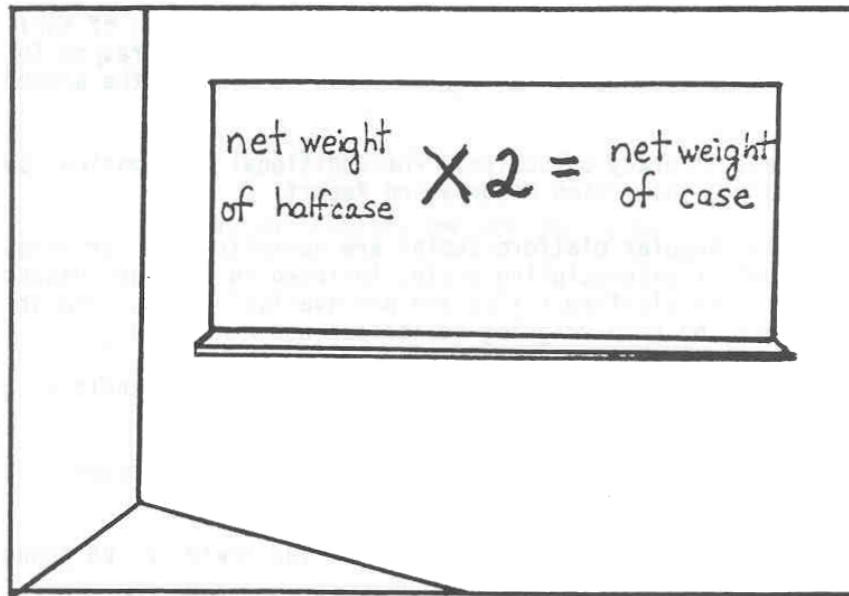

Figure 2-11. Determining net weight of a case of eggs.

(6) Record the net weight on the reverse side of DD Form 1237 (see Lesson 4 of this subcourse) or other locally approved form as appropriate.

c. **Determine Actual Net Weight of Wholesale Grade Shell Eggs.** Net weight may be obtained by one of two methods, by weighing a half-case or a whole-case sample. The half-case sample is more commonly used.

(1) Whole-case sample. You may determine the net weight of eggs packed in uniform (one-type-construction) fiber cases by removing all eggs from at least two cases and obtaining the average tare (case and packing materials) per case. Then weigh each sample case and obtain the net weight by subtracting the average tare from the gross weight. An average tare may not be used for wood cases.

(2) Half-case sample. You will be weighing one compartment of eggs.

(a) Remove half-case sample from the container (all fillers, flats, and eggs) (figure 2-12).

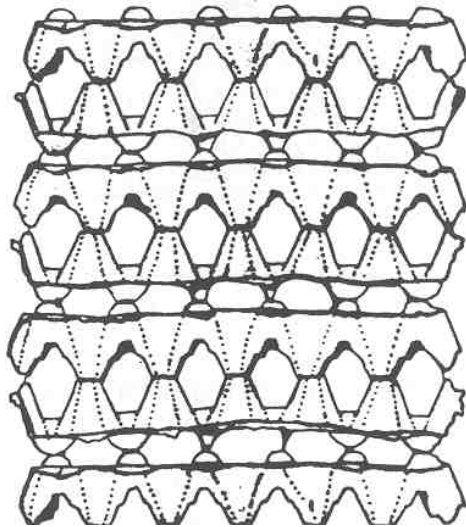

Figure 2-12. Six layers of eggs.

(b) Weigh the half-case on the scale to the nearest 1/4 pound (fig. 2-13). If a layer has one or more eggs missing from the tray, the missing eggs are not replaced.

(c) Multiply the gross weight of the sample (half-case by two) in order to obtain the total gross weight of the cases.

(d) Determine the tare weight of the half-case. If domestic shipment, use standard tare (3 1/2 pounds, if fillers and flats, or 2 pounds if filler-flats). If the inspector has 20 or more sets of fillers and flats available for weighing, he may determine a tare for the lot, rather than using the standard tare (figure 2-14).

(e) Subtract the tare weight from the gross weight to obtain the net weight of the sample (half-case).

(f) Record the net weight on the reverse side of DD Form 1237 (see Lesson 4) or other locally approved form as appropriate (figure. 2-15).

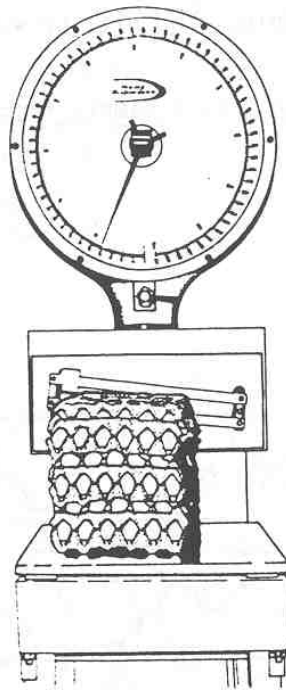

Figure 2-13. Weighing a half-case of eggs.

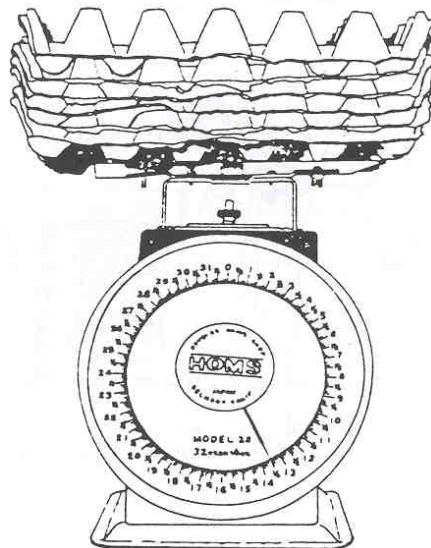

Figure 2-14. Weighing egg trays.

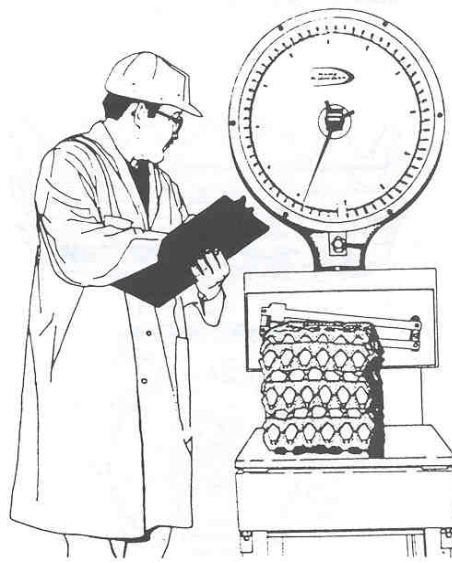

Figure 2-15. Recording net weight of egg sample.

## **2-16. CLASSIFYING SHELL EGGS**

Classifying shell eggs is a part of the condition inspection of shell eggs. See Lesson 3 of this subcourse for the procedure used in selecting eggs for classification and classifying shell eggs.

## **2-17. PREPARING REPORT OF INSPECTION OF SHELL EGGS**

As the inspection proceeds, record results of the inspection on DD Form 1237, Report of Inspection of Shell Eggs, or in accordance with local SOP. See Lesson 4 of this subcourse for the procedures in filling out DD Form 1237.

**[Continue with Exercises](#)**

## EXERCISES, LESSON 2

**INSTRUCTIONS:** The following exercises are to be answered by marking the lettered response that best answers the question or best completes the incomplete statement or by writing the answer in the space provided.

After you have completed all the exercises, turn to "Solutions to Exercises" at the end of the lesson and check your answers.

1. Acceptance inspection of shell eggs at destination is for \_\_\_\_\_, \_\_\_\_\_, and \_\_\_\_\_.
2. How can you, the veterinary food inspection specialist, identify sample cases of eggs selected for examination to avoid being presented wrong cases for the inspection?
  - a. You can apply your DOD stamp to one end of the sample cases.
  - b. You can mark an X with white chalk on each end of the sample cases.
  - c. You can apply the USDA stamp to one end of each sample case.
  - d. You can number and initial one end of each sample case.
3. You are to inspect shell eggs procured by DPSC contract. The lot size is 400 cases. The sample size is \_\_\_\_\_.
4. The total sample of 400 cases of eggs in the exercise above would be \_\_\_\_\_ cases and the total number of individual eggs examined would be \_\_\_\_\_ eggs.
5. How many individual eggs are drawn for inspection from each sample case?  
\_\_\_\_\_.

6. When you perform destination inspection of shell eggs at a military installation, you determine the identity of the product. Part of the inspection for identity is to:
  - a. Obtain the certificate for the lot and determine if the product shipped and the one received are the same.
  - b. Ask the truck driver to certify that the product being delivered is the same as the one inspected at origin.
  - c. Compare the padlock number of the truck with the number of the certificate accompanying the shipment.
  
7. Explain the procedure for determining the internal temperature of shell eggs in tray packs.
  - a. Take the center egg from the \_\_\_\_\_ of the compartment not being weighed.
  - b. Hold the thermometer securely in your hand and push the \_\_\_\_\_ of the thermometer gently into the egg.
  - c. After \_\_\_\_\_ minutes, remove the thermometer and \_\_\_\_\_ the temperature.
  
8. At time of delivery, fresh shell eggs 15 days old or less must have a case-average internal egg temperature no higher than \_\_\_\_\_ with no individual case having an internal egg temperature exceeding \_\_\_\_\_.
  
9. Determine the net weight of each sample case from a lot of consumer grade shell eggs.
  - a. Remove a sample of \_\_\_\_\_ eggs from the container.
  - b. Weigh the 15 dozen eggs in their carton to the nearest \_\_\_\_\_ pound.
  - c. Determine the \_\_\_\_\_ and subtract it from the weight of the 15 dozen egg sample.
  - d. Multiply \_\_\_\_\_ by \_\_\_\_\_ in order to obtain the actual net weight of the case.

10. You are determining the net weight of a sample case of wholesale grade shell eggs. The contents of one compartment (eggs and trays) weigh 26 pounds and 2 ounces. The tare of six empty trays is 1 pound. What is the net weight of the case?  
\_\_\_\_\_.
11. You, the veterinary food inspection specialist, are performing a destination inspection of shell eggs. Individual cartons of consumer grade shell eggs are marked with the official USDA grademark. Must a USDA Poultry Products Grading Certificate accompany the shipment?
- a. Yes.
  - b. No.
12. You, the veterinary food inspection specialist, are performing a destination inspection of wholesale grade shell eggs for troop issue. Must a USDA Poultry Products Grading Certificate accompany the shipment?
- a. Yes.
  - b. No.
13. Condition 1 eggs are fresh eggs that have not been held in storage in excess of \_\_\_\_\_ days.
14. Condition 2 eggs are Condition 1 eggs that have been treated with oils or other processing fluids to seal the pores.
- a. True.
  - b. False.
15. Wholesale grade shell eggs are normally procured and utilized for \_\_\_\_\_.
16. Consumer grade shell eggs are normally procured and utilized for \_\_\_\_\_.

17. When you examine shell eggs to determine if an inspection was performed by the USDA, you are inspecting for:

- a. Identity.
- b. Condition.
- c. Quantity.
- d. Count.

18. The six weight classes of consumer grade shell eggs are:

- a. \_\_\_\_\_.
- b. \_\_\_\_\_.
- c. \_\_\_\_\_.
- d. \_\_\_\_\_.
- e. \_\_\_\_\_.
- f. \_\_\_\_\_.

19. The four weight classes of wholesale grade shell eggs are:

- a. \_\_\_\_\_.
- b. \_\_\_\_\_.
- c. \_\_\_\_\_.
- d. \_\_\_\_\_.



20. For consumer grade shell eggs, how many cartons are selected from each sample container in order to determine net weight?
- a. 5.
  - b. 10.
  - c. 15.
  - d. 20.

**Check Your Answers on Next Page**

## SOLUTIONS TO EXERCISES, LESSON 2

1. Identity, count, and condition. (para 2-1a)
2. d (para 2-7c)
3. 5 cases. (figure 2-4)
4. 5 cases, 500 eggs. (figure 2-4; para 2-6c)
5. 100. (para 2-6b)
6. a (para 2-8; para 2-9c)
7.
  - a. center layer
  - b. sensing portion
  - c. 5; record. (para 2-12e(3))
8. 60°F (16°C), 65°F (18°C). (para 2-12e(1))
9.
  - a. 15 dozen eggs
  - b. 1/4
  - c. tare weight
  - d. net weight by two (para 2-15b)
10. 50 1/4 pounds (26 lb 2 oz - 1 lb (tare) = 25 lb 2 oz  
25 lb 2 oz X 2 = 50 lb 4 oz = 50 lb 1/4 pounds). (para 2-15b)
11. b (para 2-9a)
12. a (para 2-9c)
13. 30 days. (para 2-10a(1))
14. a (para 2-10a(2))
15. Troop issue. (para 2-10b(1))
16. Resale. (para 2-10b(2))
17. a (para 2-11b(2))

18.
  - a. Jumbo.
  - b. Extra large.
  - c. Large.
  - d. Medium.
  - e. Small.
  - f. Peewee.  
(fig. 2-9; para 2-4b)
  
19.
  - a. Extra large.
  - b. Large.
  - c. Medium.
  - d. Small.  
(fig. 2-10)
  
20.
  - c. (para 2-14a)

**End of Lesson 2**

## **LESSON ASSIGNMENT**

### **LESSON 3**

Classifying and Grading Shell Eggs.

### **LESSON ASSIGNMENT**

Paragraphs 3-1 through 3-24.

### **LESSON OBJECTIVES**

After completing this lesson, you should be able to:

3-1. Identify correct procedures for classifying shell eggs.

3-2. Determine the grade of a sample of shell eggs.

### **SUGGESTION**

After studying the assignment, complete the exercises of this lesson. These exercises will help you to achieve the lesson objectives.

## LESSON 3

### CLASSIFYING AND GRADING SHELL EGGS

#### Section I. QUALITY FACTORS FOR GRADING/CLASSIFYING

##### 3-1. GENERAL

a. Grading/classifying generally involves the sorting of products according to quality, size, weight, and other factors that determine the relative value of the product. The grading of shell eggs depends upon the classifying of the individual eggs according to established standards. United States Standards for Quality of Individual Shell Eggs have been developed on the basis of such interior quality factors as condition of the white and yolk, the size and condition of the air cell, and the exterior quality factors of cleanliness and soundness of the shell. These standards cover the entire range of edible eggs.

b. Eggs are also classified according to weight (or size) expressed in ounces per dozen. Although eggs are not sold according to exact weight, they are grouped within relatively narrow weight ranges or weight classes, the minimum weight per unit being specified.

c. Egg grading, then, is the grouping of eggs into lots having similar characteristics as to quality factors of the shell, air cell, yolk and white, and the weight.

d. Although color is not a factor in the US Standards and Grades, eggs are sometimes sorted for color and sold as either "whites" or "brown." Usually, eggs that are sorted as to color and packed separately, sell better than when sold as "mixed colors."

e. To summarize, the quality factors considered when grading eggs are: the shell, the air cell, the yolk, and the white. All four are of equal value, so the egg is assigned the same quality as the lowest quality assigned to any one of the factors. For example, an egg with an air cell, white, and yolk of A Quality but a shell factor of B Quality is rated as a B Quality egg.

##### 3-2. QUALITY STANDARDS

a. Standards of quality are used as a basis for establishing grades. Standards of quality apply to the individual eggs. Grades apply to lots of eggs such as dozens, 30-dozen cases, and carloads. Shell eggs are separated by quality and weight and are classified by the USDA as AA Quality, A Quality, and B Quality for official grades. Additional classifications are: B\* Quality, Dirty, Check, Leaker, or Loss.

b. As egg quality is unstable and grading procedures are largely subjective, it is necessary to provide tolerances in grades for small percentages of eggs of a quality lower than that comprising the major part of the grade. The tolerances are provided to allow for errors in judgment, errors in the sample, differences in interpretation, and normal deterioration in quality from the time of grading during a reasonably short period until the eggs are sold to the consumer.

### **3-3. GENERAL QUALITY FACTORS**

a. Quality may be defined as the inherent properties of a product which determine its degree of excellence. Those conditions and characteristics which consumers want and for which they are willing to pay are in a broad sense factors of quality. The quality of an egg is determined by comparing a number of factors. The relative merit of one factor alone may determine the quality score of the egg, since the final quality score can be no higher than the lowest score given to any one of the quality factors.

b. Standards of quality have been developed as a means of classifying individual eggs according to various groups of conditions and characteristics that experience and research have shown to be wanted by consumers and for which they are willing to pay. Grades differ from standards in that they provide tolerances for individual eggs within a lot to be of lower quality than the grade name indicates.

c. Quality factors may be divided into two general groups: Exterior quality factors, apparent from external observation; and interior quality factors, which involve the contents of the eggs. Interior quality factors may be determined by candling or by a flock selection method based on breaking out a small number of eggs from each flock.

### **3-4. CLASSIFICATION OF EXTERIOR QUALITY**

a. The external factors of the egg--color, shape, soundness, and cleanliness of the shell--can be determined without using the candling light, but soundness of shell should be verified by candling. The method or place where this is accomplished may vary with the type of candling operation used. In hand candling operations, the examination for shell cleanliness and color and the removal of Leakers or dented Checks and misshapen eggs will be accomplished by using the case light.

b. In mass candling operations, the segregation for these shell factors is quite often the responsibility of the person who transfers the eggs onto the conveyor or "feeds" the machine. This should be done in a well lighted area. One exception would be the color segregation, which may be performed either at this position or at the packing station. This would largely depend on the type of pack desired and whether or not the machine is of the automatic packing type or if this operation is accomplished by hand.

c. The shell of an egg is judged on its shape, soundness, and cleanliness.

### 3-5. SHELL SHAPE AND TEXTURE

a. The normal egg has an oval shape with one end larger than the other, and it tapers toward the smaller end. These ends of an egg are commonly called the large end (air cell end) and the small end. Measurements of both strength and appearance of many eggs by investigators resulted in the development of the "ideal" egg shape.

b. The ideal egg is illustrated in figure 3-1. The shape of an egg can be considered different from the "ideal" but may still be considered practically normal. The grader must keep in mind a mental picture of the normal or usual shape of an egg and compare each egg as he grades it with that picture.

c. Eggs that are unusual in shape, such as those having ridges, rough areas, or thin spots, are placed in the lower grades (figure 3-1). Shell of such eggs are usually weaker than normal shells and the danger of breakage en route to the consumer lowers the utility value of the egg. Eggs of abnormal shape also lack consumer appeal. Therefore, they are excluded from the better grades.

d. Abnormal shells may result from improper nutrition, disease, or the physical condition of the hen. Sometimes a shell is cracked while the egg is still in the body of the hen. These eggs, which are commonly referred to as "body checks," are repaired by an additional deposit of shell over the cracked area that generally results in a ridged area. Depending upon the extent and severity of the ridge, these eggs may be classed as B Quality. When no ridge is in evidence, the egg may be classed as A Quality.

e. Shell eggs are divided into one of two categories of shape:

(1) Practically normal--AA and A Quality. A shell that approximates what is considered the usual shape. It is of good, even texture and strength, and free from rough areas or thin spots. Slight ridges and rough areas, such as calcium deposits, are permitted if they do not materially affect the shape, texture, and strength of the shell.

(2) Abnormal--B Quality. A shell that may be somewhat unusual, or is decidedly misshapen, or faulty in texture or strength, or that may show pronounced ridges, thin spots, or rough areas.

### 3-6. SOUNDNESS OF SHELL

a. To be graded AA, A, B, or Dirty, an egg must have a sound (unbroken) shell. Some shell defects are:

(1) Body checks. These breaks occur before the egg is laid and are healed within the oviduct. They are not downgraded for soundness, but may be downgraded for shape since the healing frequently makes the shape of the egg slightly abnormal.

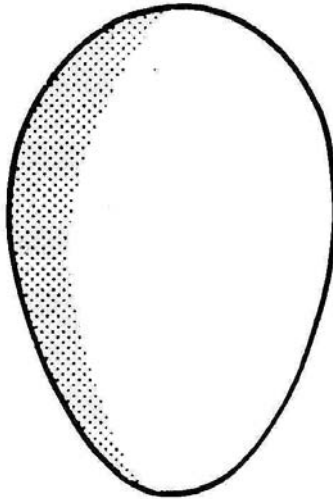

**PRACTICALLY  
NORMAL**

**A practically normal egg shape may be found in AA or A quality. It is free from thin spots. Ridges and rough areas that do not materially affect the shape and strength of the shell are permitted.**

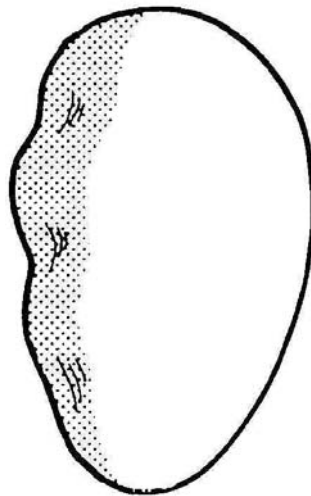

**ABNORMAL**

**An abnormal egg has a shell that may be somewhat unusual, decidedly misshapen, faulty in soundness or strength, or may have pronounced ridges or thin spots.**

Figure 3-1. Egg shapes.



(2) Check (CK). An egg is graded as a Check if it has a broken or cracked shell, but its shell membrane is intact and its contents do not leak. Blind Check, the most common type, has a very fine, hairlike crack. Dented Check has a plainly visible break, with a depression of the shell.

(3) Leaker. A Leaker is an egg with a crack or a break in the shell and shell membrane so that the contents are exuding or free to exude through the shell.

(4) Smashed. This break is more extensive than that of a Leaker; it is usually impossible to remove the egg from the case without its collapsing. At destination, inspectors record such an egg as a Leaker.

b. Checks may range from a very fine, hairlike Check (blind Check) that is discernible only before the candling light or by "belling," to plainly visible dented Checks. "Blind Checks" are the most common and frequently the most difficult to detect in rapid candling. Such eggs will not keep well or stand even moderately rough handling; hence, they should be diverted to immediate use.

c. "Belling" is the practice of tapping two eggs together gently to assist in the detection of "blind Checks" by sound. Candlers follow this practice by candling the eggs in order to verify and complete the findings arrived at by sound.

d. With the use of automatic equipment, the belling procedure generally is not used in examining the eggs for Checks. The candler must be attentive, especially when machine-mass candling and automatic packaging equipment is being used, so that all Checks are removed prior to packaging.

e. The method of removing Leakers and dented Checks need not be emphasized, except to mention that it is necessary to remove such eggs from the lot carefully to avoid doing further damage to them and to prevent dripping liquid from the Leakers onto clean eggs, onto the packaging material, or into the mechanism of the candling equipment. This is not only for good housekeeping and appearance of the packaged product, but is necessary in the use of automatic weighing equipment for keeping the mechanisms in proper adjustment.

### **3-7. SHELL CLEANLINESS**

a. In segregating eggs for shell cleanliness, the grader should make a preliminary examination of the general appearance of the layer of eggs to be candled at the time the covering tray is removed, the egg carton is opened, or the eggs in a tray are exposed to view. Eggs with only very small specks or stains may be considered clean if such eggs are not present in sufficient number to detract appreciably from the appearance of the eggs. While the eggs are still in trays, the eggs with stained or dirty shells should be removed and candled. The remaining eggs that appear clean from a

top view should be then gently pushed over on their sides, and again the eggs with stained or dirty shells should be removed or candled. These two operations will remove all dirty or stained eggs that are noticed at first glance.

b. The remaining eggs of the trays should be removed, two eggs in each hand, for candling. On the way to the candling light, the eggs in each hand should be rotated under the rays of a light that illuminates the contents of the sample. As the eggs are rotated, the shell should be observed for stains or dirty conditions.

c. This operation (rotation and observation for dirt) should be performed rapidly enough so that the motion of the hand from the case light to the candling light is made in one sweeping motion. Any stained or dirty eggs which are detected at this point should be candled and segregated before the candling of clean eggs is begun. When the eggs are placed before the candling light, previously undetected eggs with dirty or stained shells should be removed. The grader should always have clean, dry hands to avoid staining the shells. The candling aperture should be of a material that will not mark or stain the shell and will aid in minimizing breakage.

d. In machine mass candling, the examination for cleanliness is most often done on the conveyor when vacuum lifts are used or by the person putting the eggs on the receiving apparatus. This operation should be in a well lighted area, and it is preferable to have sufficient lighting directly over the conveyor and case, for ease of examination. The obvious stains or dirties can be removed directly from the case prior to transfer to the machine or they may be picked from the conveyor system, if this is used. This will depend on whichever is the most efficient method. This method of removal of soiled eggs can be very efficient if the operator has sufficient time to carefully observe the eggs.

### **3-8. CLASSIFICATION OF SHELL CLEANLINESS**

a. Freedom from stains and foreign material on the shell of eggs must be considered in assigning a quality designation to an individual egg. United States Department Agriculture regulations describe three degrees of cleanliness: clean, moderately stained, and dirty (figure 3-2). The following terms are descriptive of shell cleanliness:

(1) Clean--AA and A Quality. The shell of a clean egg is free from foreign material and from stains or discolorations that are readily visible. An egg may be considered clean if it has only very small specks or stains and if such specks or stains are not of sufficient number or intensity to detract from the generally clean appearance of the egg. Eggs that show traces of processing oil on the shell are considered clean unless otherwise soiled.

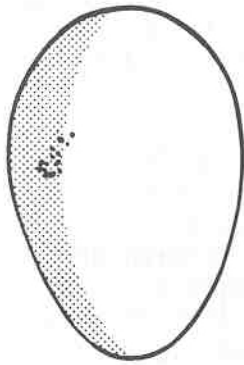

**SLIGHT STAINS**

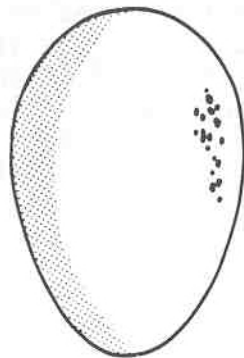
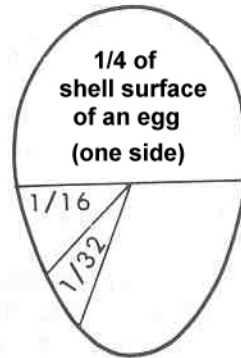

**MODERATE STAINS  
(LOCALIZED)** (Must not cover more than 1/32 of the shell surface.)

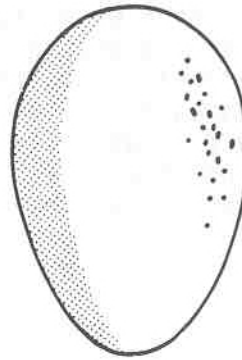

**MODERATE STAINS  
SCATTERED)** (Must not cover more than 1/16 of the shell surface.)

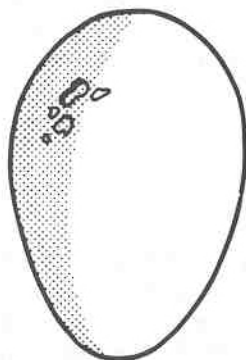

**ADHERING DIRT**

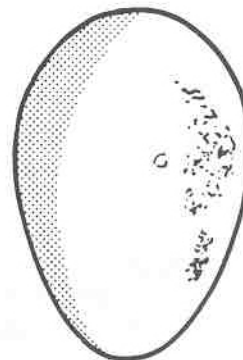

**PROMINENT STAINS**

Figure 3-2. Stained conditions of eggs.

(2) Moderately stained--B Quality. The shell of a moderately stained egg is free from adhering dirt but has slight stains that do not appreciably detract from the appearance of the egg. When the stain is localized, approximately 1/32 of the shell surface may be moderately stained. When the moderately stained areas are scattered, approximately 1/16 of the shell surface may be moderately stained. Eggs having more than 1/16 of the shell surface slightly stained may be classified as Dirty.

(3) Dirty. A Dirty egg has adhering dirt, foreign material, or prominent or moderate stains that cover more than 1/16 of the shell surface, if scattered, or more than 1/32 of the shell surface, if localized.

b. Since Dirty eggs are downgraded, producers often clean eggs before delivery. In the past, the military would not buy shell eggs that had been washed, because the available methods were not adequate for proper sanitation. Now, however, contractual documents permit cleaning shell eggs and specify the methods and equipment to be used. At present, the only approved method is to wash them. The numerous egg-washing machines on the market all work on much the same principles. The eggs are scrubbed clean by brushes and detergents, then rinsed and air-dried. Some machines wet down the eggs before scrubbing, to reduce the surface tension of the dirt. Machines also vary in methods of using water. Some reuse the wash water, adding additional water only to replace that lost in evaporation; others use fresh water for each operation. Criteria for reusing the water for shell egg cleaning operations, to include time and temperature requirements, can be located in the most current copy of the USDA "Regulations Governing the Grading of Shell Eggs and US Standards, Grades, and Weight Classes for Shell Eggs." Potable water is required for all rinse cycles.

c. The illustrations in figure 3-2 are intended as a guide. Also, the shell surface measurements are not to be used as an actual measurement in grading. Graders should learn to determine the area that constitutes these measurements and then judge eggs having soiled shells against this mental picture.

d. It is difficult to visualize the gathering together of soiled areas and apply them against a scale. However, if you, the grader, keep in mind that the total area of a normal 2-ounce egg is about 10-1/2 square inches, 1/32 of the shell surface of a 2-ounce egg would measure approximately 9/16" x 9/16", 1/16 would measure about 13/16" x 13/16".

### **3-9. SHELL COLOR**

In giving consideration to shell color, it should be borne in mind that this factor does not affect the quality of the egg and for this reason it is not considered in the US standards of quality or grades. For many years, consumers in some areas of the country have preferred white eggs, thinking, perhaps, that the quality is better than that of brown eggs, while consumers in other areas have preferred brown eggs, thinking

they have greater food value. These opinions do not have any basis in fact, but it is recognized that brown eggs are more difficult to classify as to interior quality than are white eggs. It is also more difficult to detect small blood spots in brown eggs. Then, too, consumer preference is an important factor in marketing.

### **3-10. CLASSIFICATION OF INTERIOR QUALITY**

Classification of interior quality of eggs, unlike some of the exterior qualities, cannot be determined by looking at the eggs as they lie on the trays. Eggs must be candled in order to determine the interior qualities. The interior qualities described below include the air cell, the yolk, and the white of the egg. However, before we discuss the interior quality factors, we will discuss the candling operation.

### **3-11. HAND CANDLING TECHNIQUE**

Because the modern trend in egg production is towards large, highly specialized flocks, hand candling is used very little in present commercial grading operations. Automated equipment and mass scanning devices have practically replaced these manual operations since the high-quality egg produced under this system lends itself to the use of machine mass candling equipment to detect checks, irregular shells, meat and blood spots, and loss eggs. However, hand candling is still an excellent method for teaching and demonstrating quality determination and is used for spot checking and determining accuracy in grading.

a. To determine interior quality by hand candling, you should hold two eggs in each hand, supporting one egg by the tips of the thumb and index finger and holding the other against the palm with the other fingers. The small ends of the eggs should point toward the palm of the hand (figure 3-3). After you have candled one egg in the hand, shift it back in a rotating motion to the palm of the hand and bring the second egg into candling position. View the eggs alternately before the light.

b. First, examine the uppermost egg in the right hand, then the uppermost egg in the left hand. Repeat this procedure after you have shifted the position of the eggs in each hand. After you have candled the first egg and dropped your hand slightly back and downward, relax the third and fourth fingers and let the uncandled egg roll downward slightly.

c. Use your thumb, index, and second fingers at the same time to guide the candled egg into the palm of your hand. With the third and little fingers, then roll the uncandled egg into candling position between the thumb and index finger; meanwhile your little finger (fourth) and third finger hold the candled egg in your palm. Change the position of the eggs in one hand while you are candling one of the eggs held in the other hand.

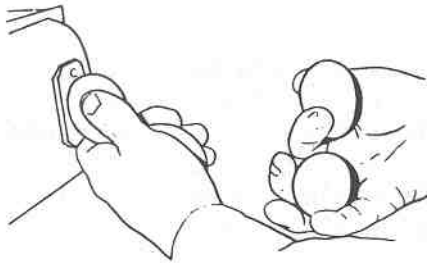
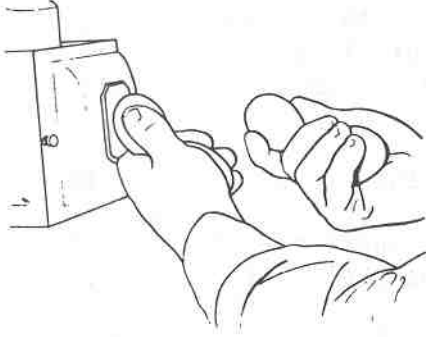

After the first egg has been candled and the hand is dropped slightly back and downward, the third and fourth fingers are relaxed. This allows the uncandled eggs to roll downward slightly. At the same time, the thumb, index, and second fingers guide the candled egg into the palm of the hand.



The third finger and little (fourth) finger then roll the uncandled egg into the candling position between the thumb and the index (first) finger.

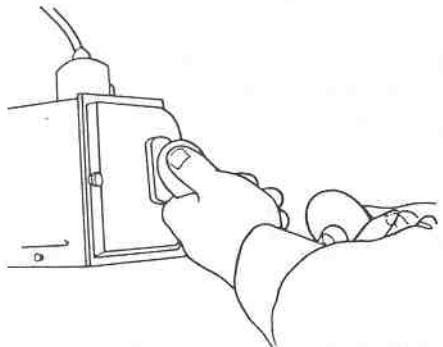

Meanwhile, the little (fourth) finger and the third finger hold the candled egg in the palm. The position of the eggs is changed in one hand while one of the eggs held in the other hand is being candled.

Figure 3-3. Hand candling technique.

d. The ability to quickly rotate two eggs in each hand makes for more rapid work. You should practice until reasonable dexterity is acquired. In manipulating eggs before the candling light, it is important that the rotation of eggs in each hand and the twirling motion before the light become mechanical.

e. Dexterity in this rotation operation permits you to concentrate entirely on placing the egg before the light rather than on changing its position or rotating the two eggs and frees you from concern over dropping the eggs. It also helps you to develop a rhythm that improves uniform timing of judgment, thereby making possible greater proficiency.

f. In order to properly view the egg while candling, you must have the contents spinning within the shell at the time of viewing. You can achieve this in one smooth motion when you are rotating the two eggs in the one hand and moving your hand toward the aperture in the candling light. The contents of the egg will be set in motion by a movement of hand and wrist in an arc of about 180 degrees.

g. Stop the hand motion at the end of the arc without moving the arm or body to spin the contents within the shell. The long axis of the egg should be at about a 45° angle to the candling aperture. Your thumb and index finger should be on opposite sides of the shell without obstructing your view (figure 3-3). After gaining some experience in the candling operation, you will learn to have the egg content spinning at the exact instant the egg is placed before the candling aperture.

### **3-12. THE FACTOR OF JUDGMENT**

a. Even under the most favorable conditions, egg quality is relatively unstable. The interior quality of the egg deteriorates from the time it is laid until it is consumed. Sometimes quality changes render eggs useless for food before they reach consumers. However, when eggs are properly cared for, the quality decline can be minimized and the period of time between original high quality and uselessness can be lengthened materially.

b. In grading eggs and more specifically in classifying them according to internal quality, the grader is merely trying to group the eggs according to where each is located on "quality hill." On the basis of internal quality, edible eggs are divided into 3 groups. The highest quality class is AA. The next quality (intermediate quality) is A. The lower quality class is B. Eggs not on "quality hill" are inedible and classified as Loss eggs.

c. To become skilled in judging egg quality, it is helpful to break the classification down into steps and consider separately the various quality factors--shell, air cell, yolk condition, and condition of the white. You can concentrate with greater ease when you consider each factor separately. Later, consider all factors in combination.

d. You can develop good judgment in determining albumen and yolk condition by breaking out an egg occasionally and checking your estimate of the candled quality with the broken-out appearance.

### **3-13. AIR CELL**

The air cell is one of several interior quality factors that you must consider.

a. The temperature of the egg within the hen is approximately 105°F (41°C). In cooling to the ambient temperature after it is laid, the liquids contract more than the shell and the inner shell membrane separates from the outer shell membrane, forming the air cell. The air cell is usually formed in the blunt end of the egg because of its porosity and the loose attachment of the inner shell membrane. If it is formed in some other part, it does not cause the egg to be downgraded.

b. Further increase in the size of the air cell beyond that resulting from contraction is due to evaporation of water from the egg. The rapidity with which this takes place is caused by many factors, such as age, shell texture, temperature, and humidity. The air cell is normally at the large end of the egg and is one of the first factors observed in candling.

c. The air cell is perhaps the one quality factor that is easiest to evaluate as it can be judged objectively by a simple measuring device--the air-cell gauge. In candling, the air cell is considered by many as a relatively unimportant quality for determining the broken-out quality of an egg.

d. However, the air cell is one of the factors of the US standards. Therefore, it can be the determining factor in classifying the individual egg as to quality. Depth is the only quality factor considered that pertains to the air cell. Movement is not considered a quality factor, and the air cell may show unlimited movement and be free or bubbly.

e. The depth of the air cell is the distance from its top to its bottom when the egg is held with the air cell upward. The following terms are descriptive of the air cell:

(1) Free air cell. An air cell that moves freely toward the uppermost part in the egg as the egg is rotated slowly.

(2) Bubbly air cell. A ruptured air cell resulting in one or more small separate air bubbles, which usually float beneath the main air cell. Bubbles often accompany checks, so eggs with bubbly air cells should be observed closely when determining the grade.



f. The size and movement of the air cell which are permitted in the various qualities are as follows:

<u>Quality</u>	<u>Depth</u>	<u>Movement</u>
AA	Not over 1/8 inch	May show unlimited movement and may be free or bubbly
A	Not over 3/16 inch	May show unlimited movement and may be free or bubbly
B	Not over 3/8 inch	May show unlimited movement and may be free or bubbly
B*	No limit	May show unlimited movement and may be free or bubbly

### 3-14. AIR CELL GAUGE

a. The air cell gauge may be used by the beginner until he can learn to judge the size of the air cell accurately at a quick glance while candling. More experienced candlers occasionally use the gauge to check the accuracy of their determinations.

b. The depth of the air cell is measured at the point of greatest distance between the top of the cell and an imaginary plane passing through the egg at the lower edge of the air cell where it touches the shell (figure 3-4). Air cell movement is the distance the air cell moves away from its normal position when the egg, with the air cell uppermost, is twirled.

### 3-15. THE YOLK

a. **General.** The appearance of the yolk as the egg is twirled in candling is one of the best indicators of the interior quality of shell eggs. The characteristics of the yolk are determined by the shadow that it casts upon the shell before the candling light. The appearance of the yolk is dependent on the condition of the albumen. However, there are three factors about the yolk itself that are considered in judging egg quality by the yolk. These are:

- (1) Distinctness of yolk shadow outline.
- (2) Size and shape of yolk.
- (3) Defects and germ development.

POINT FROM WHICH  
TO MEASURE  
AIR CELL DEPTH

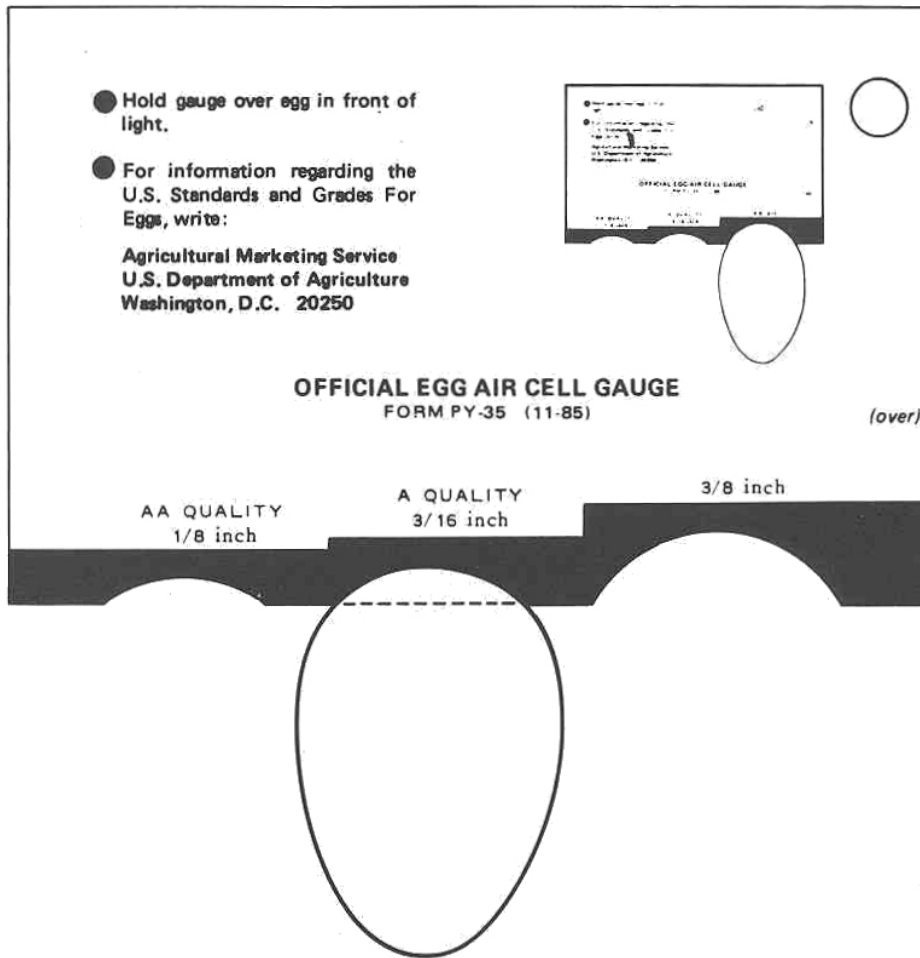
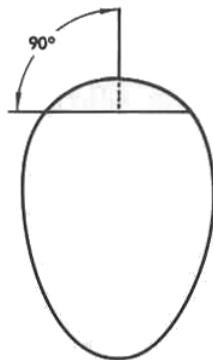

Figure 3-4. Measuring the depth of the air cell.

b. **Distinctness of Yolk Shadow Outline.** The distinctness of the yolk outline or shadow outline is governed by three factors:

(1) The thickness and consistency of the albumen. The thicker the albumen, the less distinct the outline appears, because the yolk is prevented from moving close to the shell.

(2) Condition of the yolk. This condition is determined by the presence of blemishes that show up before the candling light as dark shadows in the yolk, or the absence of these blemishes; and the presence or absence of an off-colored yolk which shows as a grayish or greenish shadow.

(3) Color of the yolk. It is difficult to determine the color of the yolk before the candling light, except for off-color. However, extremes in yolk color may influence the candler's judgment of the egg quality. An extremely deep-colored yolk, under some conditions, would cast a darker shadow before the candling light than would a lighter yolk. By concentrating on the yolk outline instead of the depth of the yolk shadow, the grader will minimize the influence of yolk color on his quality determinations. The color of the yolk and the firmness of the albumen are two influences that affect the distinctness of the yolk shadow outline. Therefore, a grader cannot be even reasonably certain which is the more important factor in any specific case. The principle of judging distinctness of the outline rather than the depth or darkness of the shadow can be illustrated by holding a ball close to a wall so its shadow falls on the wall, and then holding it a little farther away from the wall. At the greater distance, the outline of the shadow is less distinct.

c. **Degrees of Distinctness.** The terms used to define the three degrees of distinctness of yolk shadow outline in the US standards of quality for shell eggs are given below (see figure 3-5).

(1) Outline slightly defined--AA Quality. A yolk outline that is indistinctly indicated and appears to blend into the surrounding white as the egg is twirled.

(2) Outline fairly well defined--A Quality. A yolk outline that is discernible but not clearly outlined as the egg is twirled.

(3) Outline plainly visible--B Quality. A yolk outline that is clearly visible as a dark shadow as the egg is twirled.

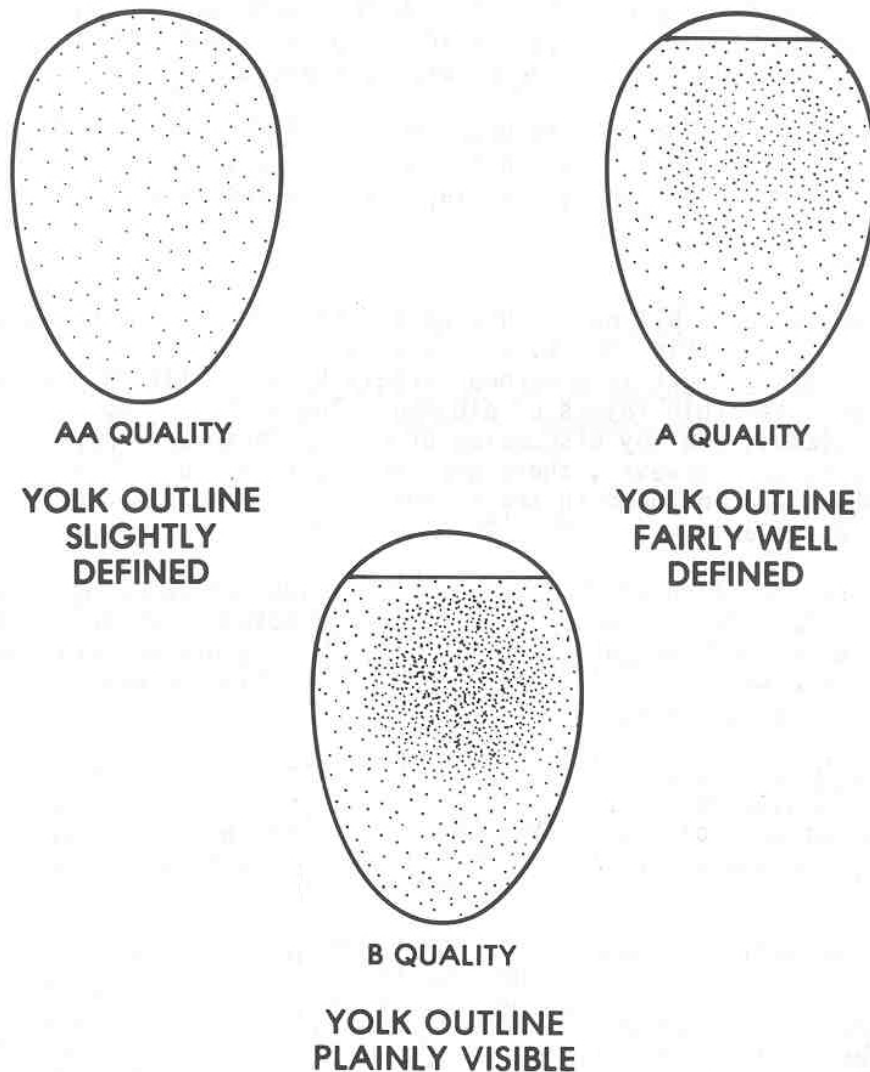

Figure 3-5. Canded appearance of the yolk.

d. **Size and Shape of Yolk.** The yolk in a new-laid egg is round and firm. As the yolk ages, it absorbs water from the albumen which increases its size and causes it to stretch and weaken the vitelline membrane and to assume a somewhat flattened shape on top and an "out-of-round" shape generally, resembling a balloon partially filled with water. Yolk size and shape are mentioned only in the lower quality classifications for eggs--B and B\*--where these factors become apparent. The terms used in the US standards of quality for shell eggs to describe yolk size and shape are: enlarged and flattened. This terminology refers to a yolk in which the yolk membranes and tissues have weakened and moisture has been absorbed from the white to such an extent that it appears definitely enlarged and flattened.

e. **Defects and Germ Development.** Relatively little is known about the exact causes of most yolk defects other than those due to germ development. Some of the causes which have been advanced are: irregular deposits of light and dark yolk;

blemishes from rubbing; and development of accumulations or clusters of the fat and oil in droplets. The relative viscosity of the albumen has a direct bearing on the accurate determination of defects on the yolk before the candling light. Unless yolk defects are very prominent, detection of them is difficult particularly when the egg has a thick albumen. Germ development is visible before the candling light and can generally be detected as a circular dark area near the center of the yolk shadow. If blood is visible, the egg must be rejected as inedible. The terms used to describe yolk defects are:

(1) Practically free from defects--AA and A Quality. A yolk that shows no germ development but may show other very slight defects on its surface.

(2) Clearly visible germ development--B Quality. Development of the germ spot on the yolk of a fertile egg that has progressed to the point where it is plainly visible as a circular area or spot with no blood in evidence. Meat spots aggregating no more than 1/8 inch (3 mm) in diameter may be present.

(3) Serious yolk defects (SYD)--B\* Quality. A yolk that shows well-developed spots or areas and other serious defects, such as an olive yolk, which do not render the egg inedible. Small blood spots aggregating no more than 1/8 inch (3 mm) in diameter may be present.

(4) Blood due to germ development. Blood caused by development of the germ in a fertile egg to a point where it is visible as definite lines or as a blood ring. Such an egg is classified as inedible.

### **3-16. THE WHITE**

a. Practically all new-laid eggs contain four layers of albumen--chalaziferous, inner thin, thick, and outer thin. The appearance of the egg before the candling light is governed largely by the relative proportions of the thick and outer thin layers of albumen. The white and yolk are very closely associated, and any discussion of either factor, of necessity, involves the other. However, there are two important considerations about the white that are included in the standards of quality: condition (viscosity) and clarity.

b. The condition of the white is determined in candling by the intensity of the yolk shadow and the freedom of movement of the yolk as the egg is twirled before the candling light. These factors are related to the viscosity of the white. Thick whites permit only limited movement of the yolk and an indistinct shadow results.

c. The reverse is true of thin whites, which permit free movement of the yolk and a distinct shadow results. You, the inspector, must judge from the behavior of the yolk, how the white will appear when the egg is broken out. The appearance of the albumen in broken-out eggs is illustrated in figure 3-6.

d. The following terms are descriptive of the white:

(1) Clear--AA or A Quality. A white that is free from discolorations or from any foreign bodies floating in it. (Prominent chalazae should not be confused with foreign bodies such as blood clots.)

(2) Firm--AA Quality. A white that is sufficiently thick or viscous to prevent the yolk outline from being more than slightly defined or indistinctly indicated when the egg is twirled.

(3) Reasonably firm--A Quality. A white that is somewhat less thick or viscous than a firm white. A reasonably firm white permits the yolk to approach the shell more closely, thus causing the yolk outline to appear fairly well defined when the egg is twirled.

(4) Weak and watery--B Quality. A white that is weak, thin, and generally lacking in viscosity. A weak and watery white permits the yolk to approach the shell closely, thus causing the yolk outline to appear plainly visible and dark when the egg is twirled.

(5) Small meat spots--B Quality. Small meat spots (MS) are blood clots or spots not due to germ development which are found on the surface of the yolk or floating in the white. These blood clots may have lost their characteristic red color and appear as small spots or foreign material of a dark gray color, commonly referred to as meat spots. The egg is classified as B Quality if the meat spots are small, aggregating not more than 1/8 inch (3 mm) in diameter.

(6) Small blood spots--B\* Quality. Small blood spots (SS) may be found on the surface of the yolk which have a characteristic brilliant red color. A slight diffusion into the white around the localized spot is acceptable. The egg is classified as B\* Quality if the blood spots are small, aggregating not more than 1/8 inch (3 mm) in diameter.

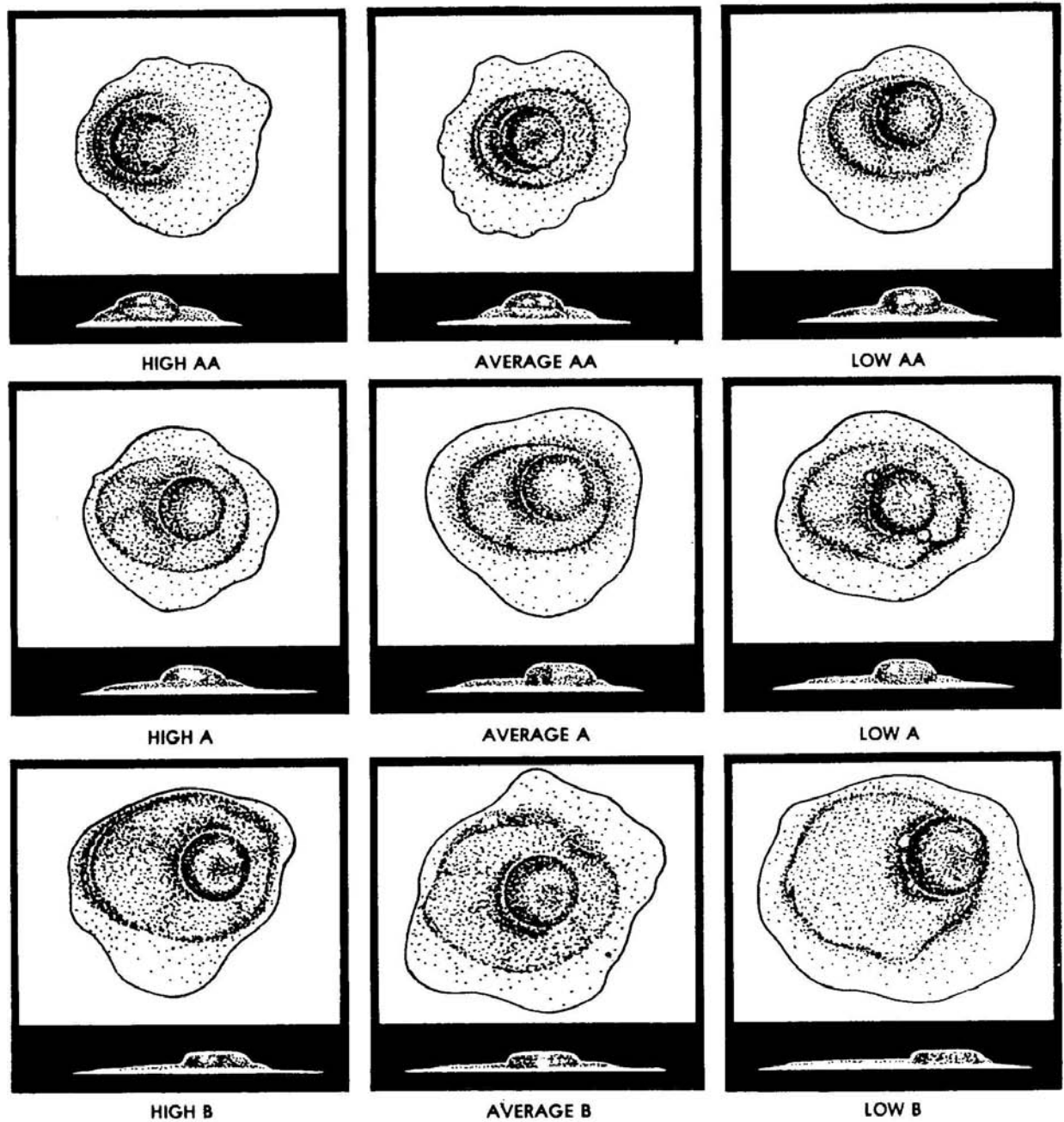

Figure 3-6. Broken-out appearance of eggs.

(7) Bloody white. An egg which has blood diffused through the white. Such a condition may be present in new-laid eggs. Eggs with bloody whites are classified as inedible.

### 3-17. YOLK AND WHITE

Yolk and white are considered together, since the condition of one influences the condition or grading of the other. For example, the firmer the white, the more difficult it is to see the yolk outline (figure 3-5). The conditions that determine grade classifications are as follows:

a. **AA Quality.** The white must be clear and firm so that the outline of the yolk is only slightly defined when the egg is twirled before the candling light. The yolk must be practically free from apparent defects.

b. **A Quality.** The white must be clear and at least reasonably firm, so that the outline of the yolk is only fairly well defined when the egg is twirled before the candling light. The yolk must be practically free from apparent defects.

c. **B Quality.** The white may be weak and watery so that the yolk outline is plainly visible when the egg is twirled before the candling light. The yolk may appear dark, enlarged, and flattened, and may show clearly visible germ development. It must not show blood as a result of such development but may show other serious defects that do not render the egg inedible. Small blood spots or meat spots, not over 1/8 inch (3 mm) in diameter may be present.

### 3-18. BROKEN-OUT APPEARANCE (SETTING THE SIGHTS)

a. All the various quality factors are considered in combination when the inspector decides to break out an egg. The inspector views several eggs before the candling light, determines the egg quality, and then uses the egg break-out plate to confirm the actual quality of one of the eggs. This procedure is called "setting the sights." It provides feedback as to the egg inspector's proficiency in determining quality.

b. It is recommended that each inspection station secure and use the USDA chart entitled "US Standards for Quality of Individual Shell Eggs." It clearly depicts, in color, the actual quality grade to be assigned based on the plumpness of the yolk, the amount and density of the thick white, and the condition of the shell.

c. The interior quality factors have been covered in this lesson. However, when an egg is broken out, you will observe that the AA Quality egg covers a small area and has a small amount of thin white, that the A Quality egg covers a moderate area and has a medium amount of thin white, and that the B Quality egg covers a very wide area and has a large amount of thin white thinly spread. See figure 3-6.



### 3-19. LOSS EGGS

a. **General.** The US Standards of Quality define certain eggs as Loss. Loss eggs are inedible eggs. An egg that is cooked, frozen, contaminated by bacteria or molds, or that contains foreign material is classified as a Loss egg. More than one loss condition often occurs in an egg. In such cases, the most serious condition is scored. Loss eggs are classified into two major categories: Loss, large spots (LS) and Loss, Other (any loss condition other than large spots).

b. **Loss, Large Spots.** Large blood spots and large meat spots are classified as Loss, Large Spots or Loss, LS. Blood spots are caused by intrafollicular bleeding at the time of ovulation. The blood may adhere to the yolk membrane or be included in the egg white (albumen). Meat spots are either blood spots that have changed color due to chemical action or tissue cast off from the reproductive organs of the hen. In contrast to the yolk, these large spots appear as brilliant red or dark gray when observed before the candling light. An egg is classified as a Loss, LS when a large spot exceeding 1/8 inch in size is observed.

c. **Loss, Other.** Loss eggs other than LS are classified as Loss, Other. A freshly laid egg is usually free of bacteria or molds on the inside and is well protected from bacteria by the shell, shell membranes, and several chemical substances in the egg white. If subjected to warm temperatures or moisture, or both, bacteria are able to penetrate the egg and overcome the egg's defenses. When bacteria grow inside the egg, they may form by-products or cause the contents of the egg to decompose, or both. These conditions result in the characteristic colors, appearance, or odors from which the rots or molds take their name. Loss Other eggs are described in the listing that follows. Note that each condition has its own abbreviation.

(1) Stuck yolk. Stuck yolk (SY) occurs when the yolk membrane adheres to the shell membrane. It generally occurs in older eggs that have been left in a fixed position for a long time. When the thick white becomes thin, the yolk floats close to the shell and becomes attached to the shell membrane. Before the candling light, the yolk appears attached to the shell and snaps back to its attached position when the twirling motion of the egg is stopped. The point of adherence usually appears as a dark spot, often resembling an area of mold. If loosened from its position, the yolk membrane usually breaks, permitting the yolk content to seep into the white. The first stage of this condition is generally referred to as "seeping yolk;" later "mixed rot" or "addled egg."

(2) White rot. In the early stage, white rot (WR) may be detected by the presence of threadlike shadows in the thin white. In the late stage, the yolk, when placed before the candling light, appears severely blemished and is crusted when broken out. The contents frequently give off a fruity odor. This rot is a type of general bacterial decomposition, probably caused by heterogeneous flora, but few attempts have been made to determine the specific organisms responsible. It develops into mixed rot. Because white rot is similar to yellow rot, inspection personnel often disagree in classifying this type of Loss egg.

(3) Yellow rot. In its initial stages, yellow rot (YR) is often hard to differentiate from heavy mottling of the yolk. The vitelline membrane is often opaque and very thick and white in places. The breaking down of the yolk membrane allows the yolk pigment to enter the white, turning it a straw or urine color. Yellow rot may be caused by a type of general bacterial decomposition. It is assumed to develop into a mixed rot.

(4) Mixed rot. Mixed rot (MR) (addled egg) occurs when the vitelline membrane of the yolk breaks and yolk material mixes with the white. The resultant murkiness throughout the egg can be detected before the candling light. This rot is a generalized type of bacterial decomposition, probably caused by heterogeneous flora. Many consider mixed rot as an intermediate stage that develops prior to black rot.

(5) Sour rot (SR). Sour rot (SR) is very difficult to detect and is especially prevalent in eggs that have been stored. The egg has an ammonia-like odor when it is broken out on a plate. Generally, eggs in this condition show a weak white and murky shadow around an off-center swollen yolk. The bacteria causing sour rot belong to a genus named Pseudomonas. These organisms produce a material which fluoresces under ultraviolet light (back light), giving off a green sheen. The adoption of ultraviolet light in candling has made the detection of this type of loss easier.

(6) Green whites. Eggs with green whites (GW) can be detected by an experienced grader using a standard candling light. (This condition is difficult for an inexperienced grader to detect.) This type of loss is also caused by the Pseudomonas genus of bacteria. Like sour rot, eggs with green whites will fluoresce under the ultraviolet light when broken out. Eggs with GW may or may not have a sour odor.

(7) Black rot. Black rots (BLRT) are generally opaque (with the exception of the air cell) when viewed before the candling light. When broken, the contents have a muddy brown appearance and give off a repulsive, putrid odor. The bacteria most frequently causing this type of loss belong to a genus named Proteus. However, any rot at an advanced stage may appear "black" before the candling light.

(8) Musty eggs. Musty (MSTY) eggs frequently appear clear and free from foreign material when viewed before the candling light and can generally be detected only by the characteristic musty odor emanating from the egg. Sources of contamination may be a musty odor in the case or the nesting material, or the presence of this odor on the shell itself. It is said that certain bacteria that occasionally invade the egg give off this characteristic odor also. Since this type of loss is impossible to detect by visual observation, it is important that the grader be able to detect the odor emanating from the case and packing material immediately upon opening the case.

(9) Moldy eggs. A moldy (MLDY) egg is always classified as Loss whether the mold is in the egg or on the shell, because most of the fungi present on the shell surface can penetrate it and multiply inside the egg. The occurrence of mold in an egg depends to some extent on the temperature and relative humidity at which the egg is held. The higher the temperature and humidity, the greater the chance for mold development. Mold development generally follows stuck yolks. At first, growth may be confined to the inner surface of the shell, the outer surface of the shell membrane, and the membranes in the air cell. As the mold multiplies, it may penetrate the albumen. If it reaches the yolk, the vitelline membrane may rupture and permit the mold to flourish. In the advanced state, mold grows through the egg and may appear similar to black rot.

(10) Cooked. Cooked (CKD) eggs are eggs which have been subjected to heat resulting in coagulation of the contents. Cooked eggs, when held before the candling light may be identified by the presence of threadlike shadows in the albumen indicating a slightly cooked egg, or a dark, opaque appearance indicating complete coagulation of the contents.

(11) Blood rings and embryo chicks. Blood rings (BR) and embryo chicks are caused by germ development occurring in fertile eggs held at incubation temperatures. At a rather early stage in incubation (after 24 hours), the embryo develops a circulatory system. If at this stage the embryo dies, the blood drains to the outer edge of the germ disc, causing the blood ring. Before the candling light, it appears as a brilliant blood-red circle from 1/8 to 3/8 inch (3mm to 10mm) in diameter, depending on the stage of development. If incubation temperatures are maintained for a longer period, the embryo chick is formed by about the third day and eventually fills most of the egg. This can be observed before the candling light as an actual outline of the embryo in the early stages.

(12) Smashed. Smashed eggs (SM or S) are classified as Loss eggs during origin verification inspection, but as Leakers at destination verification inspection.

(13) Bloody white (BW). Bloody white (BW) Loss has blood diffused through the white. The condition may be present in a newly laid egg and is due to intrafollicular hemorrhage. Most investigators are convinced that some hens are congenitally subject to producing eggs with intrafollicular hemorrhages, although the condition may be related to diet. Eggs with blood spots which show only a slight diffusion into the white around the localized spot are not to be classed as bloody white.

(14) Frozen eggs. Eggs begin to freeze at 28.5°F (-2°C). The shells of nearly all eggs will break parallel to their long axis when frozen (FZ). One exception is eggs with large air cells; these eggs normally do not split when frozen. All frozen eggs, whether the shell is split or intact, are classified as Loss.

(15) Foreign bodies. All eggs containing parasites or any foreign material are Loss eggs.

## Section II. STANDARDS FOR QUALITY

### 3-20. GENERAL

a. The US Standards for Quality of Individual Shell Eggs are applicable only to eggs of the domesticated chicken that are in the shell. Interior egg quality standards are based on the apparent condition of the interior contents of the egg as it is twirled before the candling light. You may use any type or make of candling light that will enable you to make accurate determination of the interior quality of shell eggs. It is desirable to break out an occasional egg and compare the broken-out appearance with the candled appearance. For a summary of egg quality factors that have been discussed in Section I, see figure 3-7.

	GRADE AA	GRADE A	GRADE B
Break Out Appearance	Covers a small area.	Covers moderate area.	Covers a wide area.
Albumen Appearance	White is thick and stands high; chalaza prominent.	White is reasonably thick, stands fairly high, chalaza prominent.	Small amount of thick white; chalaza small or absent. Appears weak and watery.
Yolk Appearance	Yolk is firm, round and high.	Yolk is firm and stands fairly high.	Yolk is somewhat flattened and enlarged.
Shell Appearance	Approximates usual shape; generally clean,* unbroken; ridges/rough spots that do not affect the shell strength permitted.		Abnormal shape; some slight stained areas permitted; unbroken; pronounced ridges/thin spots permitted.
Usage	Ideal for any use, but are especially desirable for poaching, frying, and cooking in shell.		Good for scrambling, baking, and use as an ingredient in other foods.
*An egg may be considered clean if it has only very small specks, stains, or cage marks. Source: USDA			

Figure 3-7. Overview of egg quality factors.

b. The shell egg grading regulations make provisions for "origin" and "destination" grades for consumer and wholesale grades. "Origin grading" is defined as a grading which is performed other than where eggs are retailed or consumed. Summaries of origin and destination grade requirements for consumer grades are shown in figures 3-8, 3-9, and 3-10. United States Standards for Quality of Individual Shell Eggs are quoted in the following paragraphs.

### 3-21. CANDLED APPEARANCE

a. **AA Quality.** The shell must be clean, unbroken, and practically normal. The air cell must not exceed 1/8 inch in depth, may show unlimited movement, and may be free or bubbly. The white must be clear and firm so that the yolk outline is only slightly defined when the egg is twirled before the candling light. The yolk must be practically free from apparent defects.

b. **A Quality.** The shell must be clean, unbroken, and practically normal. The air cell must not exceed 3/16 inch in depth, may show unlimited movement, and may be free or bubbly. The white must be clear and at least reasonably firm so that the yolk outline is only fairly well defined when the egg is twirled before the candling light. The yolk must be practically free from apparent defects.

c. **B Quality.** The shell must be unbroken, may be abnormal, and may have slightly stained areas. Moderately stained areas are permitted if they do not cover more than 1/32 of the shell surface, if localized, or 1/16 of the shell surface if scattered. Eggs having shells with prominent stains or adhering dirt are not permitted. The shell must not appreciably detract from the appearance of the egg.

(1) The air cell may be over 3/16 inch in depth, may show unlimited movement, and may be free or bubbly.

(2) The white may be weak and watery so that the yolk outline is plainly visible when the egg is twirled before the candling light.

(3) The yolk may appear dark, enlarged, and flattened, and may show clearly visible germ development but no blood due to such development. It may show other serious defects that do not render the egg inedible. Small blood spots or meat spots (aggregating not more than 1/8 inch in diameter) may be present.

d. **Dirty.** An individual egg that has an unbroken shell with adhering dirt or foreign material, prominent stains, or moderate stains covering more than 1/32 of the shell surface, if localized, or 1/16 of the shell surface, if scattered.

e. **Check.** An individual egg that has a broken shell or crack in the shell but with its shell membranes intact and its contents do not leak. A Check is considered to be lower in quality than a Dirty.

f. **Leaker.** An individual egg that has a crack or break in the shell and shell membranes to the extent that the egg contents are exuding or free to exude through the shell.

Quality Factor	AA Quality	A Quality	B Quality	B* Quality
<b>SHELL</b>	Clean  Unbroken Practically normal	Clean  Unbroken Practically normal	Moderately stained localized area not more than 1/32 of shell surface on moderately stained scattered area not more than 1/16 of shell surface. Unbroken May be abnormal	
<b>AIR CELL</b>	1/8 inch or less in depth. May show unlimited movement and may be free and bubbly.	3/16 inch or less in depth. May show unlimited movement and may be free or bubbly.	3/8 inch or less in depth. May show unlimited movement and may be free or bubbly.	May be over 3/8 inch in depth. May show unlimited movement and may be free or bubbly. (AC)
<b>WHITE</b>	Clear	Clear	Meat spots aggregating. No more than 1/8 inch diameter may be present. May be weal and watery.	Small blood spots (aggregating not more than 1/8 inch in diameter) may be present. (SS)
<b>YOKE</b>	Outline slightly defined. Practically free from defects.	Outline may be fairly well defined. Practically free from defects,	Outline may be plainly visible. May appear dark, enlarged, and flattened. May show clearly visible germ development by no blood due to such development. May show definite but not serious defects. Meat spots aggregating not more than 1/8 inch in diameter may be present.	May show other serious defects that do not render the egg inedible (SYD) Small blood spots aggregating not more than 1/8 inch in diameter may be present.
For eggs with dirty or broken shells, the standards of quality provide three additional qualities. These are:				<b>NOTES:</b> Individual B quality eggs with an air cell (AC) more than 1/8 inch in depth, a small blood spot (SS), or serious yoke defects (SYD) must be tallied separately when verifying grade of the lot. Individual eggs not within the specifications in this summary are to be classified as less quality eggs.
Dirty		Check	Leaker	
Unbroken shell with adhering dirt or foreign material; prominent stains; or moderately stained localized area more than 1/32 of shell surface or moderately stained scattered area more than 1/16 of shell surface.		Checked or cracked but not leaking.	Shell and shell membranes broken so contents are leaking or are free to leak.	

Figure 3-8. Summary of US standards for quality of individual shell eggs.

### 3-22. UNITED STATES. CONSUMER GRADES FOR SHELL EGGS

Consumer grades are intended primarily for lots of shell eggs that have been carefully graded for retail sale. They are purchased by the military for hospital use and for resale at the commissary. See figure 3-9.

a. **"Fresh Fancy Quality"** shall consist of eggs meeting the requirements of the Quality Control Program as outlined in the USDA Egg Grading Manual.

b. **"United States Consumer Grade AA"** (at origin) shall consist of eggs which are 87 percent AA Quality. The maximum tolerance of 13 percent which may be below AA Quality may consist of A or B Quality in any combination, with not more than 1 percent B\* Quality. Not more than 5 percent Checks are permitted (7 percent for Jumbo size). Not more than 0.50 percent Leakers, Dirties, or Loss (due to meat or blood spots) are permitted in any combination. Other types of Loss are not permitted.

c. **"United States Consumer Grade AA"** (destination) shall consist of eggs which are 72 percent AA Quality. The remaining tolerance of 28 percent, which may be below AA Quality, shall consist of at least ten percent A Quality with not more than 1 percent B\* Quality. Not more than seven percent Checks are permitted (9 percent for Jumbo size). Not more than one percent Leakers, Dirties, or Loss (due to meat or blood spots) are permitted in any combination, except that such Loss may not exceed 0.30 percent. Other types of Loss are not permitted.

d. **"United States Consumer Grade A"** (at origin) shall consist of eggs which are 87 percent A Quality or better. Within the maximum tolerance of 18 percent which may be below A Quality, not more than 1 percent may be B\* Quality. Not more than 5 percent Checks are permitted (seven percent for Jumbo size). Not more than 0.50 percent Leakers, Dirties, or Loss (because of meat or blood spots) are permitted in any combination. Other types of Loss are not permitted.

e. **"United States Consumer Grade A"** (destination) shall consist of eggs which are 82 percent A Quality or better. Within the maximum tolerance of 18 percent which may be below A Quality, not more than one percent may be B\* Quality. Not more than seven percent Checks are permitted (nine percent for Jumbo size). Not more than one percent Leakers, Dirties or Loss (due to meat or blood spots) in any combination are permitted, except that such Loss may not exceed 0.30 percent. Other types of Loss are not permitted.

f. **"United States Consumer Grade B"** (at origin) shall consist of eggs which are 90 percent B Quality or better. Not more than ten percent may be Checks and not more than 0.50 percent Leakers, Dirties, or Loss (because of meat or blood spots) are permitted in any combination. Other types of Loss are not permitted.

US Consumer Grade	Quality Required <sup>1</sup>	Tolerance Permitted <sup>2</sup>	
		Percent	Quality
Grade AA .....	87 percent AA .....	Up to 13 .....	A or B <sup>5</sup> Not over 5 ... Checks <sup>6</sup>
Grade A .....	87 percent A or better ..	Up to 13 .....	A or B <sup>5</sup> Not over 5 ... Checks <sup>6</sup>
Grade B .....	90 percent B or better ..	Not over 10 ..	Checks
US Consumer Grade (Destination)	Quality Required <sup>1</sup>	Tolerance Permitted <sup>3</sup>	
		Percent	Quality
Grade AA .....	72 percent AA .....	Up to 28 <sup>4</sup> .....	A or B <sup>5</sup> Not over 7 ... Checks <sup>4</sup>
Grade A .....	82 percent A or better ..	Up to 18 .....	B <sup>5</sup> Not over 7 ... Checks <sup>4</sup>
Grade B .....	90 percent B or better ..	Not over 10 ..	Checks
<p><sup>1</sup>In lots of two or more cases or cartons, see figure 3-10 of this section for tolerances for an individual case or carton within a lot.</p> <p><sup>2</sup>For the US Consumer Grades (at origin), a tolerance of 0.50 percent Leakers, Dirties, or Loss (because of meat or blood spots) in any combination is permitted, except that such Loss may not exceed 0.30 percent. Other types of Loss are not permitted.</p> <p><sup>3</sup>For the US Consumer Grades (destination), a tolerance of one percent Leakers, Dirties, or Loss (because of meat or blood spots) in any combination is permitted, except that such Loss may not exceed 0.30 percent. Other types of Loss are not permitted.</p> <p><sup>4</sup>For US Grade AA at destination, at least ten percent must be A quality or better.</p> <p><sup>5</sup>For US Grade AA and A at origin and at destination, within the tolerances permitted for B quality, not more than one percent may be B quality because of air cells over 3/8 inch, blood spots (aggregating not more than 1/8 inch in diameter), or serious yolk defects.</p> <p><sup>6</sup>For US Grades AA and A Jumbo size eggs, the tolerance for Checks at origin and destination is seven percent and nine percent, respectively.</p>			

Figure 3-9. Summary of US consumer grades for shell eggs.



U.S. Consumer Grade	Case Quality	Origin (Percent)	Destination (Percent)
Grade AA .....	AA (min).....	77	62
	A or B .....	13	28
	Check (max).....	10	10
Grade A .....	A (min).....	77	72
	B .....	13	18
	Check (max).....	10	10
Grade B .....	B (min).....	80	80
	Check (max).....	20	20

Figure 3-10. Tolerance for individual case or carton within a lot.

g. **"United States Consumer Grade B"** (destination) shall consist of eggs which are 90 percent B Quality or better. Not more than ten percent may be Checks, and not more than 1 percent Leakers, Dirties or Loss (because of meat or blood spots) in any combination, except that such Loss may not exceed 0.30 percent. Other types of Loss are not permitted.

h. **Additional Tolerances.**

(1) For Grade AA--No individual case may exceed ten percent less AA Quality eggs than the minimum permitted for the lot average.

(2) For Grade A--No individual case may exceed ten percent less A Quality eggs than the minimum permitted for the lot average.

(3) For Grade B--No individual case may exceed ten percent less B Quality eggs than the minimum permitted for the lot average.

(4) For all grades--in lots of two or more cartons, no individual carton may contain less than eight eggs of the specified quality and no individual carton may contain less than ten eggs of the specified quality and the next lower quality. No lot is to be rejected or downgraded because of the quality of a single egg except for types of Loss other than blood or meat spots.

### 3-23. UNITED STATES WEIGHT CLASSES FOR CONSUMER GRADES

The weight classes for US Consumer Grades for Shell Eggs are as indicated in figure 3-11 and apply to all consumer grades. A lot average tolerance of 3.30 percent for individual eggs in the next lower weight class is permitted as long as no individual case within the lot exceeds five percent.

Size or Weight Class	Minimum Net Weight per Dozen	Minimum Net Weight per 30 Dozen	Minimum Net Weight for Individual Eggs at Rate per Dozen
	Ounces	Pounds	Ounces
Jumbo.....	30	56	29
Extra Large.....	27	50 1/2	26
Large.....	24	45	23
Medium.....	21	39 1/2	20
Small.....	18	34	17
PeeWee.....	15	28	--

Figure 3-11. United States weight classes for consumer grades for shell eggs.

### 3-24. UNITED STATES WEIGHT CLASSES FOR WHOLESALE GRADES

The weight classes for US Wholesale Grades for Shell Eggs are as indicated in figure 3-12 and apply to all consumer grades purchased by the military services. The military services purchase more US Consumer Grade A eggs than any other grade.

Weight Classes	Average Net Weight on Lot Basis 30-Dozen Case	Minimum Net Weight Individual 30 Dozen Case	Minimum Net Weight of Individual Eggs at Rate Per Dozen	Weight Version Tolerance for Not More Than ten percent, by count, of Individual Eggs	
	Pounds	Pounds	Ounces	Not	But
Extra Large.....	50.5	50	26	Under	Under
Large.....	45	44	23	26	24 Ozs
Medium.....	39.5	39	20	23	21 Ozs
Small.....	34	None	None	20	18 Ozs
				None	

Figure 3-12. United States weight classes for wholesale grades for shell eggs.

**Continue with Exercises**

### EXERCISES, LESSON 3

**INSTRUCTIONS:** The following exercises are to be answered by marking the lettered response that best answers the question or best completes the incomplete statement or by writing the answer in the space provided.

After you have completed all the exercises, turn to "Solutions to Exercises" at the end of the lesson and check your answers.

1. In the egg-grading process, standards of quality apply to \_\_\_\_\_ and grades apply to \_\_\_\_\_.
  - a. Individual eggs; lots of eggs.
  - b. Lots of eggs; individual eggs.
  - c. Cartons of eggs; cases of eggs.
  - d. Cases of eggs; truck or carloads of eggs.
  
2. Which of these do you consider as quality factors when you grade eggs?
  1. Color.
  2. Shell.
  3. Yolk.
  4. White.
  5. Weight.
  6. Air cell.
  - a. 2-4-5-6.
  - b. 1-2-3-4.
  - c. 1-2-5-6.
  - d. 2-3-4-6.

3. List the three quality classifications established for edible eggs by the USDA.
- a. \_\_\_\_\_
  - b. \_\_\_\_\_
  - c. \_\_\_\_\_
4. Which of the following is not a specific external quality factor of the shell of the egg?
- a. Shape.
  - b. Size.
  - c. Soundness.
  - d. Cleanliness.
5. When you candle eggs by hand, you should hold \_\_\_\_\_ eggs in each hand with the \_\_\_\_\_ end toward the palm.
- a. Two; large.
  - b. Three; large.
  - c. Two; small.
  - d. Three; small.
6. When speaking of quality factors, the difference between grades of eggs and standards of eggs is best exemplified by which of these statements?
- a. In a lot of Grade A eggs, all candled eggs must be A Quality.
  - b. In a lot of Grade A eggs, some eggs may be better than A Quality but no egg can be lower than A Quality.
  - c. In a lot of Grade A eggs, all eggs must be A Quality.
  - d. In a lot of Grade A eggs, some eggs may be below A Quality.

7. Where should you look for the air cell when you are candling eggs?
- a. In the large end of the egg.
  - b. In the small end of the egg.
  - c. In the area of the yolk.
  - d. In the area of the white where it meets the yolk.
8. The military purchases more \_\_\_\_\_ shell eggs than any other.
- a. Wholesale grade extras.
  - b. Wholesale grade specials.
  - c. United States Consumer Grade A.
  - d. United States Consumer Grade B.
9. Shell eggs are divided into two categories of shape. They are:
- a. \_\_\_\_\_
  - b. \_\_\_\_\_
10. Define belling.
- Belling is the practice of \_\_\_\_\_ two eggs together \_\_\_\_\_ to assist in the detection of \_\_\_\_\_ by \_\_\_\_\_.
11. United States Department of Agriculture regulations describe three degrees of cleanliness. They are:
- a. \_\_\_\_\_
  - b. \_\_\_\_\_
  - c. \_\_\_\_\_

12. Shell color is one of the factors that affects the quality of the egg.
- True.
  - False.
13. The terms used to define the three degrees of distinctness of yolk shadow outline are:
- \_\_\_\_\_
  - \_\_\_\_\_
  - \_\_\_\_\_

14. Match the term used to describe egg yolk defects in Column B to the egg quality in Column A.

<u>Column A</u>	<u>Column B</u>
___ a. AA or A Quality.	(1) Blood caused by germ development (with definite lines).
___ b. B Quality.	(2) Serious yolk defects (SYD), such as olive yolk.
___ c. B* Quality.	(3) Clearly visible germ development.
___ d. Inedible.	(4) Practically free from defects (no germ development).

15. The seven terms used to describe the white of the egg are:

- a. \_\_\_\_\_
- b. \_\_\_\_\_
- c. \_\_\_\_\_
- d. \_\_\_\_\_
- e. \_\_\_\_\_
- f. \_\_\_\_\_
- g. \_\_\_\_\_

16. When candling eggs, if you see meat spots over 1/8 inch in diameter floating in the egg white, you should classify the egg as:

- a. Loss.
- b. A Quality or better.
- c. B Quality.
- d. B\* Quality.

In exercises 17 through 23, determine the applicable quality, according to the quality factors for shell eggs.

17. Shell is clean and not broken. Air cell is 3/16 inch in depth. White is clear and firm. Yolk outline is slightly defined.

- a. A.
- b. B.
- c. AA.
- d. B\*
- e. Loss.

18. Shell is unbroken with adhering dirt covering more than 1/4 of its surface. Air cell is 3/8 inch in depth. White is clear and reasonably firm. Yolk appears free of defects and has a fairly well defined outline.
- a. A or better.
  - b. B.
  - c. B\*.
  - d. Dirty.
  - e. Loss.
19. Shell is unbroken and moderately stained. Air cell is over 3/8 inch in depth and moves freely. White appears weak and watery. Yolk outline appears plainly visible and flattened.
- a. A or better.
  - b. B.
  - c. B\*.
  - d. Loss.
20. Shell is slightly stained and checked but not leaking. The air cell is 3/16 inch in depth and moves freely. The white appears clear and reasonably firm. The yolk outline is plainly visible and appears dark.
- a. A or better.
  - b. B.
  - c. B\*.
  - d. Check.
  - e. Dirty.



21. Shell is clean and unbroken and normal. The air cell measures  $\frac{3}{16}$  inch in depth. The white seems clear and reasonably firm. The yolk outline is fairly well defined with no defects.
- a. AA.
  - b. A.
  - c. B.
  - d. Loss.
  - e. B\*.
22. Shell is slightly stained and unbroken. Air cell is  $\frac{3}{8}$  inch in depth and is free and bubbly. The white is clear and slightly weak. The yolk outline is plainly visible, enlarged, and flattened.
- a. Loss.
  - b. B\*.
  - c. B.
  - d. A or better.
23. The yolk outline is plainly visible, enlarged and flattened. It shows a clearly visible germ development. The air cell measures  $\frac{3}{8}$  inch in depth and is free and bubbly. The white appears weak and watery. The shell is unbroken and moderately stained.
- a. A or better.
  - b. B.
  - c. B\*.
  - d. Loss.

24. When you establish the quality of an individual egg, your final quality score is based on:
- a. The average of all scores given to all the quality factors excluding the shell.
  - b. The highest score given to one quality factor.
  - c. The average of all scores given to the quality factors.
  - d. The lowest score given to one quality factor.
25. Consider Consumer Grade shell eggs at destination. What percent of the quantity below A Quality may be Dirties, Leakers and Loss combined?
- a. 1.0 percent.
  - b. 0.50 percent.
  - c. 0.30 percent.
  - d. 0.20 percent.
26. Which of these Loss eggs can be detected before the candling light?
- a. Blood rings and embryo chicks.
  - b. Moldy growth inside the egg.
  - c. Mixed rot.
  - d. Stuck yolks.

27. Match the description in Column B to the Loss condition in Column A.

<u>Column A</u>	<u>Column B</u>
___ a. Stuck yolk.	(1) The yolk material mixes with the white. Sometimes called "addled egg."
___ b. White rot.	(2) Yolk pigment enters the white, turning the color of urine.
___ c. Yellow rot.	(3) Threadlike shadows in the thin white. When broken out, gives off a fruity odor.
___ d. Mixed rot.	(4) The yolk membrane adheres to the shell membrane. Occurs in eggs left in a fixed position for a long time.
___ e. Sour rot..	(5) Appears clear and free from foreign material. Can be detected only by the characteristic odor.
___ f.. Green whites.	(6) Generally opaque before a candling light. When broken out, gives off a putrid odor and has a muddy brown appearance.
___ g. Black rot.	(7) Difficult for an inexperienced grader to detect. When broken out, will fluoresce under ultraviolet light.
___ h. Musty eggs.	(8) A weak, white and murky shadow against an off-center swollen yolk. When broken out, there is an ammonia-like odor.

28. Match the description in Column B to the Loss condition in Column A.

<u>Column A</u>	<u>Column B</u>
___ a. Moldy eggs.	(1) Parasites in egg.
___ b. Cooked eggs.	(2) Shells broken parallel to the long axis.
___ c. Blood rings.	(3) Blood diffused through the albumen.
___ d. Embryo chicks.	(4) Contents leaking out.
___ e. Smashed eggs	(5) Candling shows a developing circulatory system.
___ f. Blood white.	(6) Blood drains to the outer edge of the germ disc.
___ g. Frozen eggs.	(7) Subjected to heat, resulting in coagulation.
___ h. Foreign bodies.	(8) Fungi present on the shell or multiplying inside.

29. In order to increase your understanding of weight classes for shell eggs, you are to classify a shipment of eggs. Assume you have several lots of eggs with average net weights as shown below. Using the information in figure 3-12, classify each lot as to its weight class (medium or large).

- a. 44.00 pounds \_\_\_\_\_.
- b. 40.50 pounds \_\_\_\_\_.
- c. 42.50 pounds \_\_\_\_\_.
- d. 48.00 pounds \_\_\_\_\_.
- e. 49.50 pounds \_\_\_\_\_.
- f. 44.50 pounds \_\_\_\_\_.
- g. 45.50 pounds \_\_\_\_\_.
- h. 39.75 pounds \_\_\_\_\_.
- i. 41.50 pounds \_\_\_\_\_.
- j. 40.50 pounds \_\_\_\_\_.

30. Assume you have received a number of cases of shell eggs with the individual case weights as listed below. Using the information in figure 3-12, classify these cases as to their proper weight class (large or medium).

- a. 44.00 pounds \_\_\_\_\_
- b. 40.50 pounds \_\_\_\_\_.
- c. 42.50 pounds \_\_\_\_\_.
- d. 48.00 pounds \_\_\_\_\_.
- e. 49.50 pounds \_\_\_\_\_.
- f. 44.50 pounds \_\_\_\_\_.
- g. 39.00 pounds \_\_\_\_\_.
- h. 39.75 pounds \_\_\_\_\_.
- i. 41.50 pounds \_\_\_\_\_.
- j. 40.50 pounds \_\_\_\_\_.

In exercises 31 through 34 are lists of descriptive terms that you might use to describe egg characteristics. To each of these terms, assign the highest USDA quality standard that would be consistent with each characteristic.

31. Terms descriptive of the shell.

- a. Clean, unbroken, practically normal. \_\_\_\_\_.
- b. Slight localized stain covering less than 1/32nd of shell surface. \_\_\_\_\_.
- c. Slight scattered stain covering less than 1/16th of shell surface. \_\_\_\_\_.
- d. Moderate stain covering less than 1/8th of shell surface. \_\_\_\_\_.
- e. Prominent stain \_\_\_\_\_.
- f. Adhering dirt \_\_\_\_\_.
- g. Pronounced ridges \_\_\_\_\_.
- h. Practically normal \_\_\_\_\_.
- i. Calcium deposits \_\_\_\_\_.
- j. Abnormal \_\_\_\_\_.
- k. Unbroken \_\_\_\_\_.
- l. Smashed (broken) \_\_\_\_\_.
- m. Parts of shell missing, in excess of an area 1/4-inch square, with shell membrane intact \_\_\_\_\_.
- n. Frozen and split \_\_\_\_\_.
- o. Thin spots or rough areas \_\_\_\_\_.

32. Terms descriptive of the air cell.

- a. Free \_\_\_\_\_.
- b. Bubbly \_\_\_\_\_.
- c. Free and bubbly \_\_\_\_\_.
- d. Unlimited movement \_\_\_\_\_.
- e. 1/8 inch or less in depth \_\_\_\_\_.
- f. 3/16 inch or less in depth \_\_\_\_\_.
- g. 3/8 inch or less in depth \_\_\_\_\_.
- h. Greater than 3/8 inch in depth \_\_\_\_\_.

33. Terms descriptive of the yolk.

- a. Outline slightly defined \_\_\_\_\_.
- b. Practically free from defects \_\_\_\_\_.
- c. Clearly visible germ development \_\_\_\_\_.
- d. Serious yolk defect \_\_\_\_\_.
- e. Small blood spot less than 1/8 inch in diameter \_\_\_\_\_.
- f. Meat or blood spots greater than 1/8 inch in diameter \_\_\_\_\_.
- g. Outline fairly well defined \_\_\_\_\_.
- h. Outline plainly visible \_\_\_\_\_.
- i. Dark, enlarged, and flattened \_\_\_\_\_.



34. Terms descriptive of the white.

- a. Clear \_\_\_\_\_.
- b. Reasonably firm \_\_\_\_\_.
- c. Weak and watery \_\_\_\_\_.
- d. Firm \_\_\_\_\_.
- e. Small blood spots less than 1/18 inch in diameter \_\_\_\_\_.
- f. Meat spots more than 1/8" in diameter \_\_\_\_\_.

35. Write the symbol used to identify the following types of Loss eggs.

- a. A small blood spot \_\_\_\_\_.
- b. A mixed rot \_\_\_\_\_.
- c. Several small meat spots with a total aggregate area of over 1/8 inch \_\_\_\_\_.
- d. A mold growth on the air cell \_\_\_\_\_.
- e. A sour rot \_\_\_\_\_.
- f. A yolk with the germ spot enlarged and outlined by blood rings \_\_\_\_\_.
- g. A black rot \_\_\_\_\_.
- h. A bloody white \_\_\_\_\_.
- i. Two small blood spots on the yolk with a 1/8 inch aggregate area \_\_\_\_\_.
- j. A frozen egg \_\_\_\_\_.
- k. A yellow rot \_\_\_\_\_.
- l. An egg with the yolk sticking to the inner shell membrane \_\_\_\_\_.

36. List the percentage requirements for consumer grade eggs at destination.  
See figure 3-9.

	<u>Grade AA</u>	<u>Grade A</u>
a. Listed quality grade.	_____	_____
b. Next lower quality grade.	_____	_____
c. B* quality.	_____	_____
d. Checks.	_____	_____
e. Leakers, Dirties, or Loss, LS	_____	_____

37. Fill in the blanks for the percentage of tolerance requirements at destination inspection for individual cases or cartons within a lot. See figure 3-10.

**Grade AA**

- a. The percentage that has to be Grade AA. \_\_\_\_\_
- b. The percentage that can be Grade A or B. \_\_\_\_\_
- c. The percentage of Checks allowed. \_\_\_\_\_

**Grade A**

- d. The percentage that has to be Grade A. \_\_\_\_\_
- e. The percentage than can be Grade B. \_\_\_\_\_
- f. The percentage of Checks allowed. \_\_\_\_\_

38. List the minimum net weight per dozen for consumer grade eggs.  
See figure 3-11.

**Weight Class**

Ounces

- |                 |       |
|-----------------|-------|
| a. Extra large. | _____ |
| b. Large.       | _____ |
| c. Medium.      | _____ |
| d. Small.       | _____ |

**Check Your Answers on Next Page**

### SOLUTIONS TO EXERCISES, LESSON 3

1. a (para 3-2a)
2. d (para 3-1e)
3. AA Quality.  
A Quality.  
B Quality. (para 3-2a; fig. 3-7)
4. b (para 3-4c)
5. c (para 3-11a)
6. d (para 3-3b)
7. a (para 3-5a)
8. c (para 3-24)
9. Practically normal.  
Abnormal. (para 3-5e)
10. Tapping; gently; checks; sound. (para 3-6c)
11. Clean.  
Moderately stained.  
Dirty. (para 3-8a)
12. b (para 3-9)
13. Outline slightly defined.  
Outline fairly well defined.  
Outline plainly visible. (para 3-15c; figure 3-5)
14. d (1)  
c (2)  
b (3)  
a (4) (para 3-15e)

15. Clear.  
Firm.  
Reasonably firm.  
Weak and watery.  
Small meat spots.  
Small blood spots.  
Bloody white. (para 3-16d)
16. a (para 3-19b)
17. a (para 3-21b and figure 3-8)
18. d (paras 3-8a(3), 3-21d and figure 3-8)
19. c (para 3-13f and figure 3-8)
20. d (para 3-21e and figure 3-8)
21. b (para 3-21b and figure 3-8)
22. c (para 3-21c and figure 3-8)
23. b (para 3-21c and figure 3-8)
24. d (para 3-3a)
25. c (para 3-22g)
26. a,b,c,d (para 3-19c)
27. d (1)  
c (2)  
b (3)  
a (4)  
h (5)  
g (6)  
f (7)  
e (8) (para 3-19c)

28. h (1)  
g (2)  
f (3)  
e (4)  
d (5)  
c (6)  
b (7)  
a (8) (para 3-19c)
29. a. Medium.  
b. Medium.  
c. Medium.  
d. Large.  
e. Large.  
f. Medium.  
g. Large.  
h. Medium.  
i. Medium.  
j. Medium. (figure 3-12)
30. a. Large.  
b. Medium.  
c. Medium.  
d. Large.  
e. Large.  
f. Large.  
g. Medium.  
h. Medium.  
i. Medium.  
j. Medium. (figure 3-12)
31. a. A or AA. (para 3-21a, b)  
b. B. (para 3-21c)  
c. B. (para 3-21c)  
d. Dirty. (para 3-21d)  
e. Dirty. (para 3-21d)  
f. Dirty. (para 3-21d)  
g. B. (paras 3-5e(2))  
h. A or better. (para 3-21a, b)  
i. A or better. (para 3-5e(1))  
j. B. (para 3-5e(2))  
k. A or better. (para 3-21a, b)  
l. Leaker (destination inspection). (para 3-19c(12))  
m. Check. (para 3-21e)  
n. Loss, Other. (para 3-19c(14))  
o. B. (para 3-5e(2))

32. a. A or AA. (paras 3-21a, b; 3-13f)  
 b. A or AA. (paras 3-21a, b; 3-13f)  
 c. A or AA. (paras 3-21a, b; 3-13f)  
 d. A or AA. (paras 3-21a, b; 3-13f)  
 e. A or AA. (paras 3-21a, b; 3-13f)  
 f. A. (paras 3-21a, b; 3-13f)  
 g. B. (paras 3-21a, b; 3-13f)  
 h. B\*. (paras 3-21a, b; 3-13f)
33. a. AA. (para 3-15c(1))  
 b. A or AA. (para 3-20a, b)  
 c. B. (para 3-15e(2))  
 d. B\*. (para 3-15e(3))  
 e. B\*. (para 3-15e(3))  
 f. Loss, LS. (para 3-19b)  
 g. A. (para 3-15c(2))  
 h. B. (para 3-15c(3))  
 i. B. (para 3-15d)
34. a. A or AA. (para 3-16d(1))  
 b. A. (para 3-16d(3))  
 c. B. (para 3-16d(4))  
 d. AA. (para 3-16d(2))  
 e. B\*. (para 3-16d(5))  
 f. Loss, LS. (para 3-19b)
35. a. SS (para 3-16d(6))  
 b. MR (para 3-19c(4))  
 c. MS (para 3-16d(5))  
 d. MLDY (para 3-19c(9))  
 e. SR (para 3-19c(5))  
 f. BR (para 3-19c(11))  
 g. BLRT (para 3-19c(7))  
 h. BW (para 3-19c(13))  
 i. SS (para 3-16d(6))  
 j. FZ (para 3-19c(14))  
 k. YR (para 3-19c(3))  
 l. SY (para 3-19c(1))
36. a. 72 percent; 82 percent.  
 b. 10 percent; 18 percent.  
 c. 01 percent; 01 percent.  
 d. 07 percent; 07 percent.  
 e. 01 percent; 01 percent. (para 3-22; figure 3-9)

37. a. 62 percent.  
b. 28 percent.  
c. 10 percent.  
d. 72 percent.  
e. 18 percent.  
f. 10 percent. (figure 3-10)
38. a. 27.  
b. 24.  
c. 21.  
d. 18. (figure 3-11)

**End of Lesson 3**

## **LESSON ASSIGNMENT**

### **LESSON 4**

Completion of Shell Egg Inspection and the Recording of Results on the DD Form 1237.

### **TEXT ASSIGNMENT**

Paragraphs 4-1 through 4-7.

### **LESSON ASSIGNMENT**

After completing this lesson, you should be able to:

- 4-1. Identify a standard sampling pattern for examining eggs.
- 4-2. Identify procedures for examining eggs.
- 4-3. Enter required information on the DD Form 1237, Report of Inspection of Shell Eggs.

### **SUGGESTION**

After studying the assignment, complete the exercises of this lesson. These exercises will help you to achieve the lesson objectives.



## LESSON 4

### COMPLETION OF SHELL EGG INSPECTION AND THE RECORDING OF RESULTS ON THE DD FORM 1237

#### Section I. ADDITIONAL INSPECTION PROCEDURES

##### 4-1. SELECTING A SAMPLING PATTERN

The sample size for classifying consists of 100 eggs.

a. For consumer grade shell eggs, eight full cartons and the middle four eggs from a ninth carton are to be selected from each case in the sample. These cartons are selected from the cartons selected for determining net weight according to a predetermined sampling plan. For an example of a predetermined sampling plan using the 15 cartons selected from each case for net weight, see figure 4-1.

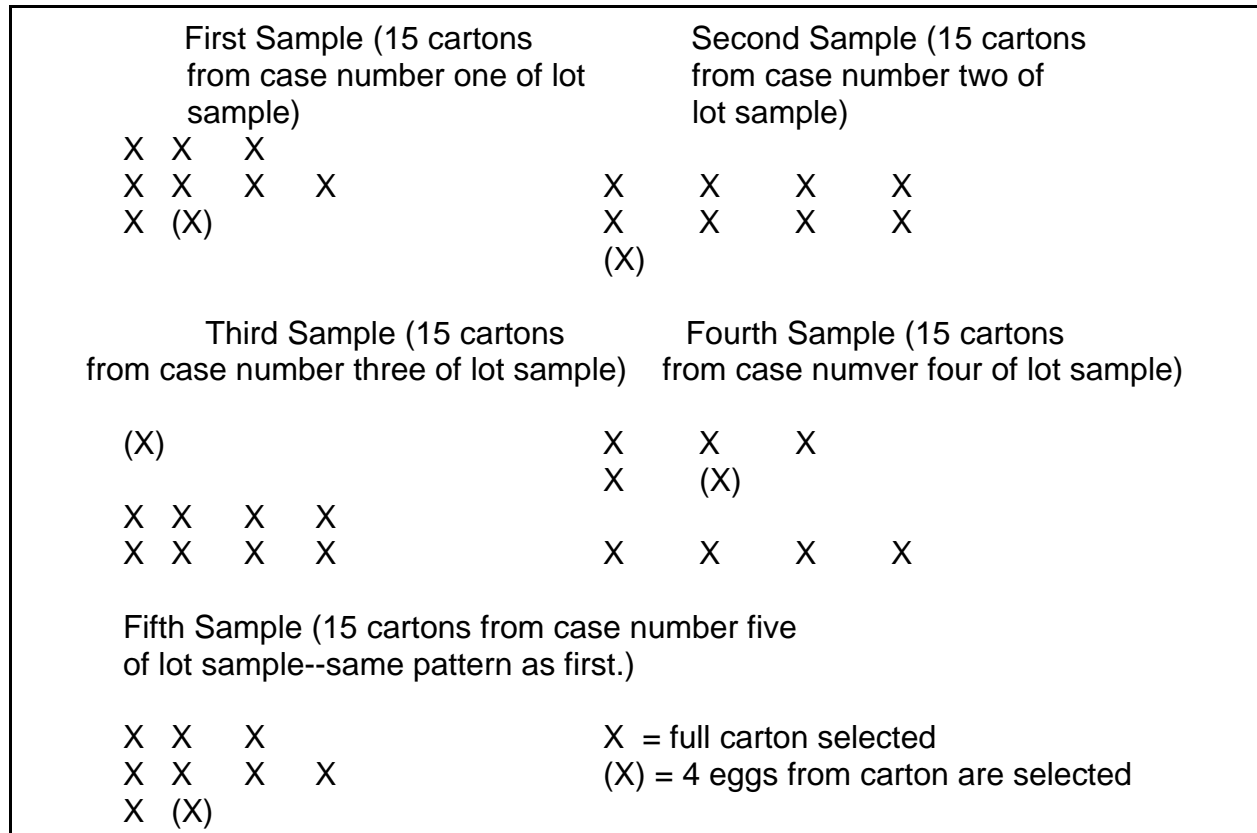

Figure 4-1. Example of a predetermined sampling plan for consumer grade eggs.

b. For wholesale grade shell eggs, examine one-half the sample cases from the marked end of the cases and the other half from the unmarked end of the cases (see para 2-5a). The odd- numbered cases, that is 1, 3, 5, 7, and so forth, could be examined on the marked end of the cases and the even-numbered cases examined on the unmarked end. From the appropriate end, three trays (30 eggs per tray) plus ten eggs from a fourth tray are selected using the predetermined sampling pattern shown in figure 4-2.

Sample Case Number	Compartment	<u>L A Y E R S</u>					
		1	2	3	4	5	6
1	Marked end	X	X	X	(X)	—	—
2	Unmarked end	—	—	X	X	X	(X)
3	Marked end	—	X	X	X	(X)	-
4	Unmarked end	X	X	—	—	X	(X)
5	Marked end	X	—	—	X	X	(X)
6	Unmarked end	Same as for number one.					
7	Marked end	Same as for number two					
8	Unmarked end	Same as for number three.					
9	Marked end	Same as for number four.					
10	Unmarked end	Same as for number five.					
Repeat the above for sample case number in excess of 10							
X = use all eggs in layer							
(X) = use only the ten eggs from the two middle five-egg rows							

Figure 4-2. Predetermined sampling pattern for 30-egg-tray, six-trays-per-compartment, wholesale grade shell eggs.

## 4-2. EXAMINING THE EGGS

When you first pick up a tray of eggs, you should visually check their appearance. First, select eggs that are Stained, Dirty, Checks, Leakers, or obviously Underweight. The light from the base glass of the candler should shine directly on the eggs.

### a. Identify Underweight Eggs in Sample.

(1) Visually examine the eggs in the tray or carton in order to identify the smallest egg. The smallest egg is then weighed. If it is found not to be underweight, then more eggs may not have to be weighed. If the egg is underweight, then additional egg(s) must be selected and weighed. The additional egg(s) is(are) the next smallest egg(s) in the tray/carton. This must be continued until the smallest remaining egg is found to be of an acceptable weight (that is, not underweight).

(2) Each tray or carton must be inspected for underweight eggs before the eggs in the tray or carton are graded.

(3) Eggs are inspected for being underweight before belling and candling are begun, but any egg that feels light when it is picked up will be weighed on the individual egg scale. See paragraph 1-14 for use of the individual egg scale.

(4) Place the egg in the cup, with the small end down, and release the egg. If the knob rests on the knob support, the egg is underweight. If the cup rests on the platform or is balanced, the egg is not underweight.

(5) If the egg is found to be underweight, adjust the beam range weights so that the scale is set for the next lower weight class. If the egg is still underweight at this setting, it is "underweight by more than one weight class."

(6) If an egg is found to be underweight, it is represented by placing an egg (either an egg in the sample or an egg which has been graded and found to be satisfactory) in the UNDERWEIGHT column of the egg tallying trays. Underweight and underweight-by-more-than-one-weight-class groups are kept separate.

(7) Underweight is not a grading classification. Any underweight egg must still go through the grade classification process.

b. **Bell Eggs.** Pick up two eggs in each hand, holding the small ends together in your palm and bell the eggs as you lift them. To bell eggs, gently tap them together. Checks give a dead sound; eggs that are not Checks give a clear, bell-like sound. Belling is particularly important in detecting blind Checks.

c. **Candle Eggs.** Before candling the eggs, adjust the candler, which may be on a candling bench (figure 1-6), so that you can stand erect with your elbows at right angles and avoid leaning. If necessary, stand on dunnage or similar material. After belling the eggs, place the front egg in your right hand before the candlelight, giving the egg a quick spin as you do so. After grading that egg, candle the front egg in your left hand in the same way, while you rotate the eggs in the right hand. Repeat the process, so that all four eggs are candled.

d. **Break Eggs Out.** After several eggs have been candled, break them out individually and compare the broken-out appearance (figure 3-6) with that observed before the candle. Then definitely establish the quality by using the USDA Egg Break-out Chart. This is called "setting your sights" and is done each time you inspect eggs. After establishing the comparison, complete the candling. If the grade assigned is not the same as the quality of the shell or air cell, give the egg the grade of the lowest quality factor.

e. **Tally.** You cannot keep an accurate mental record of all the eggs candled, so the following procedure has been devised for tallying (see figure 4-3):

(1) Place all A Quality eggs or better into a designated tallying tray (the first tray).

(2) Place all B Quality eggs, B\* Quality eggs, Dirties, and Checks in the proper rows of a separate egg tray (the second tray).

(3) In still another egg tallying tray, rows are designated for Leakers, Loss, Underweight, and Shortage eggs, and eggs are placed in the proper rows. Smashed eggs are placed in the Leaker row (the third tray).

(4) If an egg has more than one defect, A Quality eggs are used as substitutes for tallying purposes. For example, if one egg is B Quality and underweight, an A Quality egg is placed in the underweight row and the B Quality egg is placed in the row for B Quality eggs.

(5) See paragraph 1-15 for placement of trays when candling eggs.

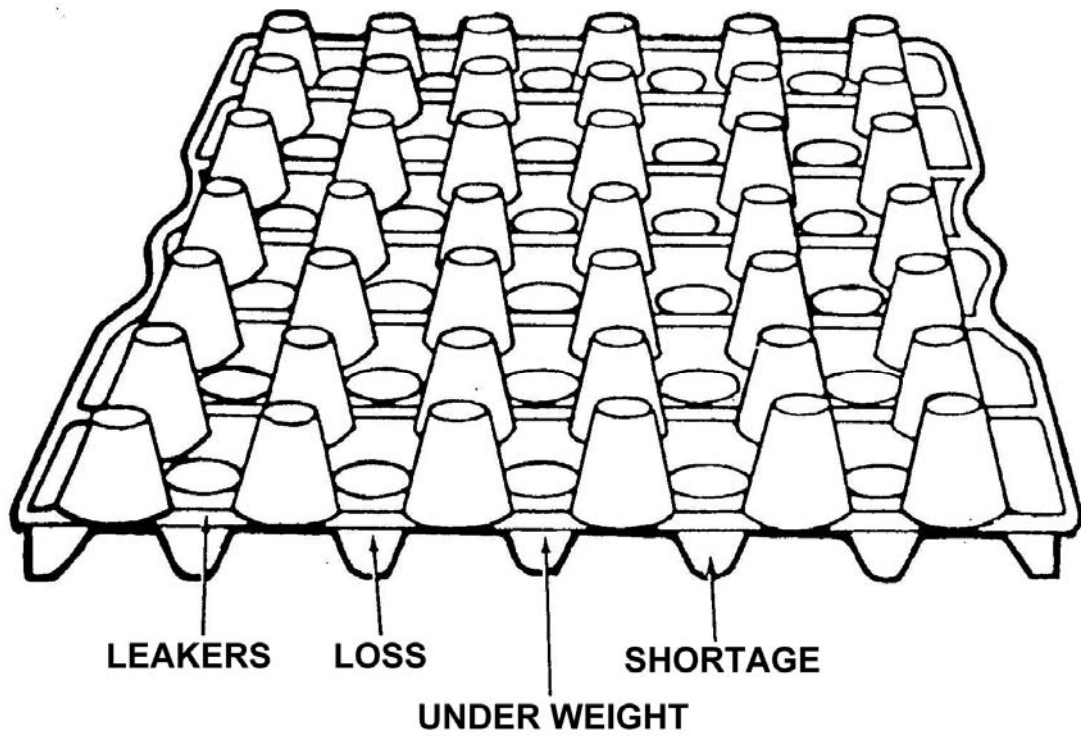
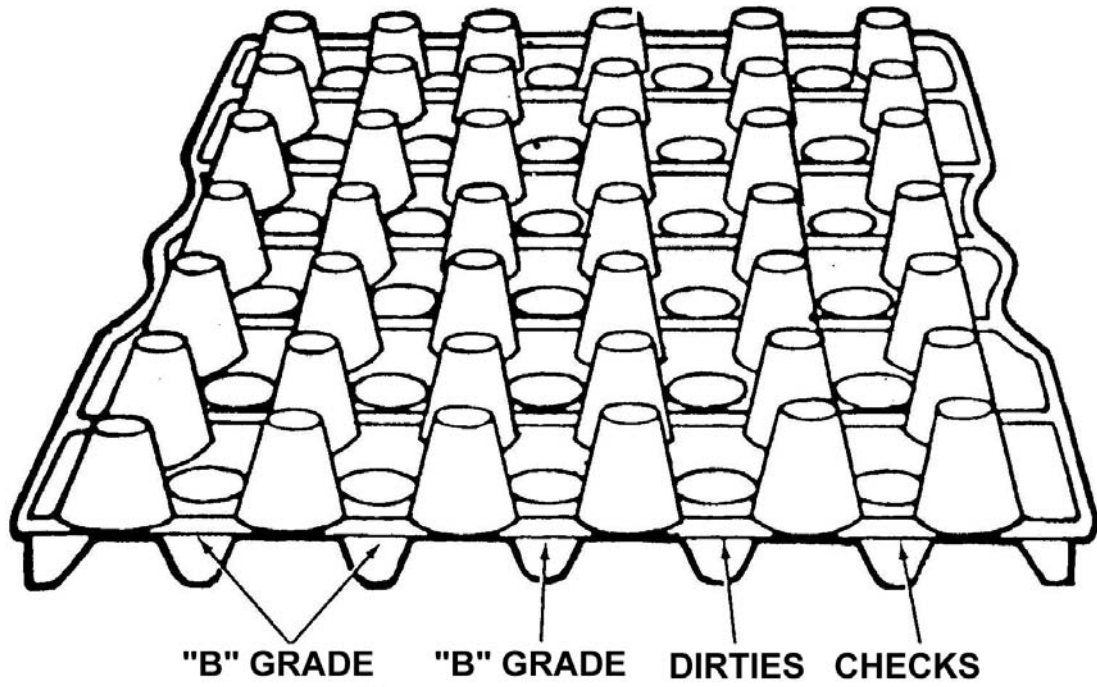

Figure 4-3. Tallying candled eggs.

f. **Count.** Add all eggs in the tally trays to determine the amount of A Quality, B Quality, B\* Quality, Dirty, Check, Leaker, Loss, Underweight, and missing eggs. For example, eggs graded A or better are normally in a separate tallying tray, so the inspector counts them and records the number of eggs. Sometimes a separate tray is not used for A Quality eggs. The inspector returns them directly to the case as they are candled. In this case, add all eggs graded Quality B and lower through Loss and subtract the total from 100.

g. **Determine Type of Loss.** After all eggs of the 100-egg sample have been classified, the eggs in the Loss column of the egg tallying tray are broken out into the breakout plate, one at a time. Each Loss is then classified as frozen, cooked, moldy, stuck yolk, black rot, white rot, yellow rot, sour rot, green white, mixed rot, bloody white, blood ring, Loss, Large Spots and Loss, Other. See paragraph 3-19 for additional information.

h. **Fill Sample Cases.** When eggs are destroyed during candling, replacement eggs should be used so that every case is filled. If enough replacement eggs are not available, each sample case, with the exception of the last one, should be filled. All vacancies should be in the top tray of the last sample case, with a note stating the number of eggs the case is short and the reason for the shortage.

i. **Utilize and Complete DD Form 1237.** Perform the inspection and list the results on DD Form 1237, Report of Inspection of Shell Eggs. Compare the information that you have entered on the reverse side of the DD Form 1237 with the basic requirements in the USDA "Regulations Governing the Grading of Shell Eggs and United States Standards, Grades, and Weight Classes for Shell Eggs." If the basic requirements are not met provisionally, reject the lot and contact responsible authorities.

#### **4-3. REPORTING REJECTIONS**

When the veterinary food inspection specialist contacts the responsible authorities to report rejection, he should use the information that has been recorded on the front side of the DD Form 1237. The following information must be furnished:

- a. Contract number.
- b. Name of contractor.
- c. Point of origin, if other than address of contractor.
- d. Destination (location where eggs were inspected).
- e. Quantity and grade or weight class of eggs.
- f. Information from block 17 on the front side of the DD Form 1237.

- g. All instances of noncompliance in the delivery.
- h. Any additional information from DD Form 1237 that is requested.

#### **4-4. CONTRACTOR OPTIONS**

When a product is rejected for noncompliance, a contractor may do one of the following:

- a. Keep the product.
- b. Offer the product at a reduced price (price adjustment), subject to acceptance by the contracting officer.
- c. Request a reinspection of the product (formal review) if the USDA performed the origin inspection. If the contractor performed the origin inspection, the shipment is NOT subject to formal review. Formal review applies to grade, not to damage.

### **Section II. THE DD FORM 1237, REPORT OF INSPECTION OF SHELL EGGS**

#### **4-5. INTRODUCTION**

In order for you to be a competent veterinary food inspection specialist, you must be able to report the findings of your inspection of shell eggs as well as make a valid inspection of the eggs. In this section, we provide instructions for recording and reporting results of inspection of shell eggs. The instruction is based on the information contained in DPSC Subsistence Inspection Manual No. 4155.6, subsection 213.2, and is directed to completion of DD Form 1237, "Report of Inspection of Shell Eggs." A separate DD Form 1237 must be completed for each size and grade received.

#### **4-6. PREPARATION OF THE REVERSE SIDE OF THE DD FORM 1237**

a. **General Information.** The reverse side of the DD Form 1237 (see figure 4-4) is utilized as an inspection worksheet for individual sample cases of shell eggs. It must be completed and kept on file even when there are no nonconformances. If there are nonconformances, the front side is then also completed and the inspection information is forwarded to DPSC. The reverse side of the form is divided into two parts by a bold back line. To the left of the line, egg quality information is recorded and computed. There are two sets of tolerances involved: Lot Average and Individual Case Tolerances. To the right of the bold line, six additional tolerances are listed. The Loss symbols are listed near the bottom of the form. There is also space for inspector remarks.

INSPECTION WORKSHEET FOR INDIVIDUAL SAMPLE CASES OF SHELL EGGS																										
EGG QUALITY (100 INDIVIDUAL EGG SAMPLE)									ADDITIONAL TOLERANCES																	
Case No.		A	B	Check	Dirty	Leaker	Loss LS Only	Loss Other	B*	Dirty Leaker Loss (LS)	Shortage	Indiv. Underwt.	Case Net Wt.	Internal Temp.												
1		90											41.68	42° F												
2		91											41.91	44° F												
3		94											41.54	46° F												
4																										
5																										
Case Avg.	%	91.67	3.67	4.66	%	%	%	%	%	%	%	%	41.71	44° F												
TOTAL		275	11	14																						
TOTAL																										
Case Avg.	%	%	%	%	%	%	%	%	%	%	%	%														
<p>LOSS SYMBOLS</p> <table border="0"> <tr> <td>MIXED ROT - MR</td> <td>BLOOD RING - BR</td> <td>STUCK YOLK - SY</td> </tr> <tr> <td>SOUR ROT - SF</td> <td>BLOODY WHITE - BW</td> <td>MOLDY - MLDY</td> </tr> <tr> <td>BLACK ROT - BLRT</td> <td>LARGE BLOOD SPOT - LS</td> <td>COOKED - CE</td> </tr> <tr> <td>GREEN WHITE - GW</td> <td>LARGE MEAT SPOT - LS</td> <td>FROZEN - FZ</td> </tr> </table>															MIXED ROT - MR	BLOOD RING - BR	STUCK YOLK - SY	SOUR ROT - SF	BLOODY WHITE - BW	MOLDY - MLDY	BLACK ROT - BLRT	LARGE BLOOD SPOT - LS	COOKED - CE	GREEN WHITE - GW	LARGE MEAT SPOT - LS	FROZEN - FZ
MIXED ROT - MR	BLOOD RING - BR	STUCK YOLK - SY																								
SOUR ROT - SF	BLOODY WHITE - BW	MOLDY - MLDY																								
BLACK ROT - BLRT	LARGE BLOOD SPOT - LS	COOKED - CE																								
GREEN WHITE - GW	LARGE MEAT SPOT - LS	FROZEN - FZ																								
<p>REMARKS</p> <p>*THE TOTAL NUMBER OF B* QUALITY EGGS MUST BE INCLUDED WITH THE FINAL TOTAL OF B QUALITY EGGS.</p>																										

Figure 4-4. Completed DD Form 1237, Report of Inspection of Shell Eggs (reverse side).



b. **Steps in the Verification of Results of Shell Egg Inspection.** The veterinary food inspection specialist performs verification inspection of the sample eggs. In summary, this includes candling, assigning each egg a quality score, determining if an egg is underweight, replacing missing eggs, and examining replacements. The final step in the process is recording the results of the inspection on the reverse side of the DD Form 1237. At this time, a specific series of steps are followed.

(1) Verify sample size. The lot size is the number of 30-dozen cases in a shipment or a 30-dozen case equivalent. Not all shipments are packed in 30 dozen cases. For example, if a shipping container has 15 dozen eggs in a case, then it is exactly one-half of a 30 dozen equivalent. The number of cases can be multiplied by .five to determine the 30-dozen equivalent. There are standard multiplication factors (found in subsection 218.8 of DPSCM 4155.6) for specific type packs which may vary considerably as to the number of dozen eggs packed in each case. (See figure 2-3 in lesson two.) An additional example: for 18 dozen eggs per shipping container, the multiplication factor for determining the 30-dozen equivalent is 0.6. For the inspection worksheet, the reference must be to a 30-dozen equivalent. Otherwise, all the calculations will not be accurate. The number of sample cases from which to select the 100 shell egg sample is shown below. It is based on the number of 30-dozen cases or an equivalent number to 30-dozen cases.

<u>Lot Size</u>	<u>Sample Size</u>
1-50	1
51-100	2
101-200	3
201-300	4
More than 300	5

(2) Verify accuracy of results. Each sample case examined must total 100 eggs. The inspector must add up all entries to the left of the bold line under EGG QUALITY. This is from A through Loss Other. It is easy enough to make a mistake in recording, so the results need to be double-checked. Remember that the ADDITIONAL TOLERANCES are not part of the 100 egg total. B\*, Shortage, Underweight Eggs, for example, are to the right of the bold line and must not be counted for the 100 egg total.

(3) Total each column. Near the bottom of the worksheet there is a place to add up the number of eggs listed in each column. This must be computed accurately. For example, all the A quality eggs are added up and a total figure is recorded. The same is done for all the other columns across the worksheet. Remember that the final total of B Quality eggs must include the total number of B\* eggs.

(4) Compute the average percentage for each column. The average percentage for each column is determined by dividing the total of each column by the number of sample cases. This information is recorded as the case average percentage at the bottom of each column. The final step is to add the percentages in the Egg Quality section to the left of the bold line (A through Loss Other). It should equal 100%. There is a USDA booklet with a blue cover which is entitled: Shell Egg Graders Percentage Tables. The use of the booklet speeds up the process and eliminates the need for computing fractions.

(5) Record the shell egg case weight and internal temperature. The actual net weight of each sample case is recorded. The total is added up. The case average net weight is determined by dividing the total by the number of sample cases. The internal temperature of a case of shell eggs is determined by eggs selected from a compartment not being used for candling. The sensing portion of a bimetallic thermometer is inserted into the egg and remains there while candling takes place. When candling is completed, the internal temperature is noted and recorded and the thermometer is placed back on the shelf. The total of all the sample cases is added up. The case average internal temperature is determined by dividing the total by the number of eggs examined.

(6) Compare inspection results with lot average requirements. A listing of the lot average tolerances follows.

- (a) A quality or better--no less than 82 percent.
- (b) B quality--no more than 18 percent (including B\*)
- (c) B\* quality--no more than 1 percent, because of:
  - 1 air cell over 3/8 inch.
  - 2 small blood spots (not more than 1/8 inch).
  - 3 serious yolk defects that do not render the egg inedible.
- (d) Checks--no more than seven percent.
- (e) Dirty, Leakers, or Loss (LS only)--no more than one percent in any combination, of which:
  - (f) Loss (LS only, edible)--no more than .three percent.
  - (g) Loss Other (inedible)--none permitted (zero percent).
  - (h) Shortage eggs--none permitted (zero percent).

(i) Temperature--no more than 60°F (see TDS for specific requirement, which may vary).

(j) Underweight eggs--no more than 3.3 percent.

(7) Compare inspection results with individual case requirements.

A listing of individual case tolerances follows.

(a) A quality or better--no less than 72 percent per case.

(b) B quality--no more than 18 percent per case (includes B\*).

(c) Checks--no more than ten percent per case.

(d) Underweight eggs--no more than 5% per case.

(e) Net weight--no less than 39.50 pounds per case (medium eggs) or 45.00 pounds per case (large eggs).

(f) Temperature--no more than 65°F (see TDS for specific requirement, which may vary).

(8) Complete verification of inspection results OR circle all nonconformances. After the inspection results are compared with the requirements and there are no tolerances that are exceeded, the verification of inspection results is completed. However, if tolerances are exceeded, they must be circled. The specific case average from the lot average must be circled and also the specific quality that was exceeded, from the individual sample case.

(9) Inspect second set of samples, if there are nonconformances. If there are any nonconformances in the initial sample, draw additional samples in accordance with USDA requirements (shown in figure 2-5) and inspect the second set of samples. The first set of samples is already recorded. The second set of samples is recorded in the space below them. The steps in the verification of results of shell egg inspection are repeated, steps one through eight.

#### **4-7. PREPARATION OF THE FRONT SIDE OF THE DD FORM 1237**

a. **General Information.** A separate DD Form 1237 must be completed for each size and each grade of shell eggs received. The front side (see figure 4-5) is completed only when there are nonconformances to be reported. On the front side, all spaces must be filled in. NA (not applicable) may be used when necessary. All nonconformances are circled in Block 17a. All blocks must be completed clearly, concisely, and correctly. Remember that the report goes to someone who has only the completed DD Form 1237 to make decisions by.

SHELL EGG INSPECTION						
1. DATE OF REPORT	2. SHIPMENT ARRIVAL a. DATE <i>5 Jul 91</i> b. TIME <i>1130</i>	3. CONTRACT NUMBER DLA13H-91-D-E044	4. INSPECTION POINT TISA C/S			
5. INSPECTION ACTIVITY a. NAME VET SVCS: WBAMC TIAS C/S b. ADDRESS (Street, City, State and Zip Code) Bldg. 325, FSH, TX 28234		6. SHIPPED TO a. NAME TIAS C/S b. ADDRESS (Street, City, State and Zip Code) SAME				
7. CONTRACTOR DATA a. NAME CF Supply Services, Inc. b. ADDRESS (Street, City, State and Zip Code) P.O. Box 31178, Jackson MS 39286-1178		8. PLANT DATA a. NAME Cal-Maine Foods Inc. b. ADDRESS (Street, City, State and Zip Code) P.O. Box 528, Gonzales, TX 78629 c. ESTABLISHMENT NUMBER				
9. PRODUCT DESCRIPTION						
a. NSN 8910-00-043-3198	b. GRADE A	c. WEIGHT CLASS Medium	d. CONDITION Fresh			
e. PACK PER CASE 30 Dozen	f. LOT SIZE (DZ) 4800	g. DATE OF PACK <i>4 Jul 91</i>	h. USDA CERTIFICATE NUMBER(S) PPA-092020			
10. CONVEYANCE NUMBER 369 XAZ	11. SEAL NUMBERS Padlock	12. STAMP NUMBER <i>5086</i>	13. DATE OF STAMP (Julian) <i>1186</i>			
14. TEMPERATURES						
a. OPENING <i>42° F</i>	b. CLOSING N/A	c. STORAGE N/A	d. INDIVIDUAL INTERNAL EGG <i>42°-44°-46° F</i>			
e. AVERAGE INTERNAL EGG <i>44° F</i>						
15. NUMBER OF SAMPLE CASES INSPECTED		16. TOTAL NUMBER OF CASES IN SHIPMENT 160				
17. EGG BREAKDOWN						
a. LOT AVERAGE TOLERANCES			b. INDIVIDUAL CASE TOLERANCES			
	(1) MIN	(2) MAX	(3) ACTUAL	(1) UNDER	(2) %	(3) QUALITY
(a) AA	0 %		<i>- 0</i> %	(4) OVER	(5) %	(6) QUALITY
A	88 %		<i>91.67</i> %	(7) OVER	(8) %	(9) CHECK QUALITY
B		18 %	<i>- 3.67</i> %	(10) UNDER	(11) NET	
Check		1 %	<i>- 4.66</i> %	(12) OVER	(13) %	(14) UNDERWEIGHTS
Dirty			<i>- 0</i> %	c. OTHER LOSS BREAKDOWN		
Leaker		1 %	<i>- 0</i> %			
Loss (LS only)			<i>- 0</i> %			
LS Loss		3 %	<i>- 0</i> %			
Other Loss		0 %	<i>- 0</i> %			
B*		1 %	<i>- 0</i> %			
(b) Shortage		0 %	<i>- 0</i> %			
(c) Individual Underweights		3.3 %	<i>- 0</i> %			
(d) Net Weight	39.5		<i>41.71</i>			
18. REMARKS						
19. QUALITY ASSURANCE REPRESENTATIVE						
a. TYPED OR PRINTED NAME (Last, First, Middle Initial) <i>Jeffery A. Bryan</i>	b. RANK/GRADE <i>Sgt</i>	c. SIGNATURE <i>J.A. Bryan</i>	d. DATE SIGNED <i>5 Jul 91</i>			

Figure 4-5. Completed DD Form 1237, Report of Inspection of Shell Eggs (front).

**b. Block by Block Instruction.**

- (1) Block 1: Date of Report. Enter day, month, and year. Example: 16 September 92.
- (2) Block 2: Shipment Arrival. For (a), enter the date (day, month, and year). For (b), enter the time the product is delivered. Use military time.
- (3) Block 3: Contract Number. Enter the appropriate DLA contract number.
- (4) Block 4: Inspection Point. Examples: Commissary, cold storage, supply point.
- (5) Block 5: Inspection Activity. For (a), enter name of inspection office. Example: VF10. For (b), enter official address of the office.
- (6) Block 6: Shipped To. For (a), enter name of addressee. Example: Commissary Officer, Troop Issue Subsistence Officer. For (b), enter official address of addressee.
- (7) Block 7: Contractor Data. For (a), enter prime contractor's name. For (b), enter complete address of contractor.
- (8) Block 8: Plant Data. This entry may be the same as block 7. If different, in block 8 (a) and (b), enter the egg packer's name and complete official address. For (c), enter the official establishment number of the source plant.
- (9) Block 9: Product Description.
  - (a) National Stock Number (NSN). Example: 8910-00-926-6148.
  - (b) Grade. Example: AA, A, or B.
  - (c) Weight Class. Example: large, medium.
  - (d) Condition. Example: fresh, shell protected, process.
  - (e) Pack Per Case. Enter two items: the total number of cases in the shipment (manifest case count) and the number of dozen per case.
  - (f) Lot Size (Dozen). Total number of dozens in the shipment. To obtain the lot size, multiply the case count and the number of dozen per case from block (e).

(g) Date of Pack. Enter date of pack on case or carton, as appropriate.

(h) United States Department of Agriculture Certificate Number. Enter the official number from the USDA Poultry Products Grading Certificate. If a certificate does not accompany the shipment, an explanation must be recorded in Block 18, Remarks.

(10) Block Ten: Conveyance Number. Enter type of conveyance and number. Example: Truck number 67, Trailer number 733, Railcar number 675129.

(11) Block 11: Seal Numbers. If the conveyance is sealed and the inspector sees that the seals are intact, enter the seal numbers. If the seals are broken prior to the inspector's arrival, so state in Block 18, Remarks. If the conveyance is secured with a padlock, so state.

(12) Block 12: Stamp Number. Enter the four digit serial number of the inspection stamp that is assigned to the inspector performing the inspection.

(13) Block 13: Date of Stamp. Enter the current Julian date of the stamp impression which was applied to the sample cases upon completion of inspection.

(14) Block 14: Temperatures.

(a) Opening. Enter the opening temperature of the truck or trailer or railcar. This is applicable to inspection classes 3, 4, 5, 7, and 8.

(b) Closing. Enter the closing temperature for inspection classes 3, 6, and 7. Enter NA for inspection classes 4, 5, 8, or 9.

(c) Storage. Enter the storage room temperature if it is a class nine inspection. Otherwise, enter NA.

(d) Individual Internal Egg. Enter each individual egg temperature as recorded on the worksheet. There are usually three entries.

(e) Average Internal Egg. Enter here the average of the temperatures recorded in block (d).

(15) Block 15: Number of Sample Cases Inspected. Record the initial sample size. Also, record the number of additional cases candled, if required. Example: 3 + 5 = 8. 3 (initial sample) + (plus) 5 (additional sample) = (equals) 8 (the total combined sample).

(16) Block 16: Total Number of Cases in Shipment. Record the total number of 30 dozen cases or 30 dozen equivalent cases. To do this, divide the total manifest dozen (see block 9f) by 30. Round the end result to the nearest full case. Example: 2500 divided by 30 = 83.

(17) Block 17: Egg Breakdown.

(a) Lot Average Tolerances. Enter in blocks (1) and (2) the minimum and maximum requirements for the grade of eggs being inspected. Use lines (a) through (d). Enter in block (3), the actual lot average percentages of the samples inspected from the reverse side of the form. Circle the nonconformances.

(b) Individual Case Tolerances. Enter individual case tolerances and nonconformances. In the first column, enter in block (10) the requirement for the individual case weight. In the second column, enter individual case tolerances in blocks (2), (5), and (8) and the requirement for underweight eggs in block (13). In the third column, write NONE in those blocks where the cases are conforming. For the nonconformances, in blocks (3), (6), (9), and (14), enter the individual samples, by sample case number, that are over or under the minimum or maximum requirements. Circle the nonconformances.

(c) Other Loss Breakdown. Identify Other Loss using the listing of Loss symbols, by count, name, and abbreviation. Example: four Bloody White (BW) or two Mixed Rot (MR).

(18) Block 18: Remarks. Enter all information or explanation affecting contract administration. Enter the name of the individual to whom the nonconformance was reported, the date and the time. Enter any action taken and authority for the action.

(19) Block 19: Quality Assurance Representative. Enter the name of inspector, the rank or grade, the signature of the inspector, and the date the report was signed.

**Continue with Exercises**

## EXERCISES, LESSON 4

**INSTRUCTIONS:** The following exercises are to be answered by marking the lettered response that best answers the question or best completes the incomplete statement or by writing the answer in the space provided.

After you have completed all the exercises, turn to "Solutions to Exercises" at the end of the lesson and check your answers.

1. You are to select for examination individual eggs from a compartment of a sample case. The eggs are packed 30 dozen per tray (layer). You draw the samples by choosing:
  - a. Ten eggs from each tray in the compartment.
  - b. Twenty-eight eggs from each of the first three trays.
  - c. All the eggs from three trays and 10 eggs from a fourth tray.
  - d. All of the eggs from the first three trays.
  
2. In your sampling pattern, you are examining eggs from sample case number two. The eggs are packed 30 dozen per tray (layer). Select the predetermined sampling pattern.
  - a. Odd-numbered case, marked end, trays 2, 3, 4, with 10 eggs from tray 5.
  - b. Even-numbered case, unmarked end, trays 1, 2, 5, with 10 eggs from tray 6.
  - c. Odd-numbered case, marked end, trays 1, 2, 3, with 10 eggs from tray 4.
  - d. Even-numbered case, unmarked end, trays 3, 4, 5, with 10 eggs from tray 6.
  
3. When eggs are examined to determine if they are underweight, which step is performed first?
  - a. Grading.
  - b. Belling.
  - c. Candling.
  - d. Weighing.



**Special Instructions for Exercises 4 through 6.** Assume you are candling an egg sample from a sample case selected from a lot of shell eggs.

4. In which tallying tray are B\* Quality eggs and Dirties placed?
  - a. First tray.
  - b. Second tray.
  - c. Third tray.
  
5. In which row of the tallying tray are Loss eggs placed?
  - a. Second row.
  - b. First row.
  - c. Fourth row.
  - d. Third row.
  
6. When eggs are destroyed during candling, replacement eggs are used. All vacancies should be in the:
  - a. First sample case, evenly distributed.
  - b. Last row of each sample case.
  - c. Last sample case, evenly distributed.
  - d. Last sample case, the top tray.
  
7. Concerning the use of DD Form 1237, both large and medium-size shell eggs may be reported on the same copy of the form.
  - a. True.
  - b. False.

8. What is the purpose of the reverse side of the DD Form 1237, Report of Inspection of Shell Eggs?
  - a. It serves as a report for the vendor.
  - b. It serves as an information sheet for the OIC of the inspection unit.
  - c. It serves as a worksheet for the inspector.
  - d. It serves as a report to the CQAF at DPSC.
  
9. The shell egg inspection worksheet (reverse side of DD Form 1237) is completed. It is then:
  - a. Forwarded to the CQAF at DPSC.
  - b. Disposed of once the data is recorded.
  - c. Faxed to a data bank.
  - d. Kept on file in the local unit office.
  - e. Both "c" and "d" above.
  
10. The type pack for a shipment is 18 dozen per shipping container. The total manifest dozen is 2400. What is the 30 dozen case equivalent?
  - a. 2880.
  - b. 2304.
  - c. 750.
  - d. 1388.
  - e. 1440.

**Special Instructions for Exercises 11 through 17.** Answer the exercises based upon the inspection worksheet shown below.

INSPECTION WORKSHEET FOR INDIVIDUAL SAMPLE CASES OF SHELL EGGS														
EGG QUALITY (100 INDIVIDUAL EGG SAMPLE)								ADDITIONAL TOLERANCES						
Case No.		A	B	Check	Dirty	Leaker	Loss LS Only	Loss Other	B*	Dirty Leaker Loss (LS)	Shortage	Indiv. Undervwt.	Case Net Wt.	Internal Temp.
1		78	13	6	1	1	0	1	2	2	0	2	40.0	52°F
2		81	10	7	1	0	1	0	1	2	0	3	40.25	56°F
3														54°F
4														
5														
Case Avg.	%	%	%	%	%	%	%	%	1.5%	2.0%	0%	2.5%		
TOTAL									3	4	0	5		

11. Verify the accuracy of each sample case.
  - a. Does sample case number one total 100 eggs? \_\_\_\_\_
  - b. Does sample case number two total 100 eggs? \_\_\_\_\_
  
12. What is the TOTAL for each column under EGG QUALITY?
  - a. A Quality. \_\_\_\_\_
  - b. B Quality. \_\_\_\_\_
  - c. Check. \_\_\_\_\_
  - d. Dirty. \_\_\_\_\_
  - e. Leaker. \_\_\_\_\_
  - f. Loss, LS Only. \_\_\_\_\_
  - g. Loss, Other. \_\_\_\_\_

13. What is the Case Average Percentage for each column under EGG QUALITY?
- a. A Quality. \_\_\_\_\_
  - b. B Quality. \_\_\_\_\_
  - c. Check. \_\_\_\_\_
  - d. Dirty. \_\_\_\_\_
  - e. Leaker. \_\_\_\_\_
  - f. Loss, LS Only. \_\_\_\_\_
  - g. Loss, Other \_\_\_\_\_
14. Verify the total percentage under EGG QUALITY. Does the percentage add up to 100 percent? \_\_\_\_\_
15. Determine the total net weight of the two samples and the case average net weight.
- a. Net weight total \_\_\_\_\_.
  - b. Case average net weight \_\_\_\_\_
16. Three eggs have been examined for internal temperature, from two sample cases. (See the example.)
- What is the case average? \_\_\_\_\_
17. Compare the inspection results in the example with the lot average requirements (paragraph 4-6). How many case average percentages exceed the requirements? The number of nonconformances, which you must circle are \_\_\_\_\_.

18. The individual case requirements are:
- a. A Quality-no less than \_\_\_\_\_percent per case.
  - b. B Quality-no more than \_\_\_\_\_ percent per case.
  - c. Checks-no more than \_\_\_\_\_ percent per case.
  - d. Underweight eggs-no more than \_\_\_\_\_ percent per case.
  - e. Medium eggs, net weight-no less than \_\_\_\_\_pounds.
  - f. Large eggs, net weight -no less than \_\_\_\_\_ pounds.
  - g. Internal temperature-no more than \_\_\_\_\_ Fahrenheit.
19. Review figure 4-5, DD Form 1237. In which numbered block of DD Form 1237 do you enter the contract number for the shipment of shell eggs you have inspected?
- a. 1.
  - b. 2.
  - c. 3.
  - d. 4.
20. Assume that the total number of cases in a shipment is 120 and that the number of dozen eggs per case is 30. What is the correct entry for block 9f, Lot Size, Dozen?
- a. 2,400.
  - b. 3,000.
  - c. 3,450.
  - d. 3,600.

21. What should you enter in block 13 of DD Form 1237? The:
- a. Julian date of inspection.
  - b. Inspector's stamp number.
  - c. Conveyance number.
  - d. Average internal egg temperature.
22. Where can you get the official number required for block 9h? From:
- a. The contractor listed in block 3.
  - b. The list of National Stock Numbers.
  - c. The USDA Poultry Products Grading Certificate.
  - d. The unbroken seal on the conveyance.
  - e. The contract listed in block 3.
23. In which numbered block of DD Form 1237 do you record the average egg internal temperature?
- a. 14a.
  - b. 14e.
  - c. 14d.
24. Assume that sample cases numbers 3 and 4 have 12 actual Checks each. These are nonconformances. In which numbered block of DD Form 1237 do you record this information?
- a. 17a (3), fourth space.
  - b. 17b (8).
  - c. 17a (2), fourth space.
  - d. 17b (9).

25. It is a requirement to circle the nonconformances entered on the reverse side of the DD Form 1237. On the front side of the form, should you circle the nonconformances related to lot average tolerances?
- a. Yes.
  - b. No.
26. Give two examples of entries for block 17c of DD Form 1237.
- a. \_\_\_\_\_
  - b. \_\_\_\_\_

**Check Your Answers on Next Page**

## SOLUTIONS TO EXERCISES, LESSON 4

1. c (para 4-1b)
2. d (para 4-1b; figure 4-2)
3. d (para 4-2a(3))
4. b (para 4-2e(2))
5. a (para 4-2e(3); figure 4-3)
6. d (para 4-2h)
7. b (para 4-5)
8. c (para 4-6a)
9. d (para 4-6a)
10. e (para 4-6b(1)) Use the multiplication factor in the lesson (six).  
 $2600 \times 6 = 1440$
11. a. Yes  
b. Yes (para 4-6b(2))
12. a. 159  
b. 23  
c. 13  
d. 2  
e. 1  
f. 1  
g. 1 (para 4-6b(3))
13. a. 79.5 percent  
b. 11.5 percent  
c. 6.5 percent  
d. 1.0 percent  
e. .5 percent  
f. .5 percent  
g. .5 percent (para 4-6b(4))
14. Yes (para 4-6b(4))



15. a. 80.25  
b. 40.12 (para 4-6b(5))
16. 54°F. (para 4-6b(5))
17. Three. (B\* in the example is already circled.) Circle: A Quality, Loss (LS Only), and Loss (Other). (para 4-6b(6), (8))
18. a. 72 percent  
b. 18 percent  
c. 10 percent  
d. 5 percent  
e. 39.50  
f. 45.00  
g. 65°F (para 4-b(7))
19. c (para 4-7b(3))
20. d (para 4-7b(9)(f))
21. a (para 4-7b(13))
22. c (para 4-7b(9)(h))
23. b (para 4-7b(14)(e))
24. d (para 4-7b(17)(b))
25. a (para 4-7b(17)(a))
26. 4 Bloody White (BW)  
2 Mixed Rot (MR) (para 4-7b(17)(c))

**End of Lesson 4**

## **LESSON ASSIGNMENT**

### **LESSON 5**

Surveillance Inspection of Shell Eggs.

### **TEXT ASSIGNMENT**

Paragraphs 5-1 through 5-8.

### **LESSON OBJECTIVES**

After completing this Lesson, you should be able to:

- 5-1. Identify storage requirements for shell eggs.
- 5-2. Identify methods used to lengthen storage life.
- 5-3. Identify surveillance inspection procedures.

### **SUGGESTION**

After studying the assignment, complete the exercises of this lesson. These exercises will help you to achieve the lesson objectives.

## LESSON 5

### SURVEILLANCE INSPECTION OF SHELL EGGS

#### 5-1. INSPECTION RESPONSIBILITY

The veterinary food inspection specialist is also responsible for surveillance inspection of shell eggs. The purpose of surveillance inspections is to watch over government- owned food supplies to ensure they remain in good condition and to recommend action to be taken if their condition deteriorates. Surveillance inspections are Classes 5, 6, 7, and 9. These government-owned food supplies are also inspected to determine if they are wholesome and suitable for shipment, consumption, further storage, issue, or sale. The basic inspection procedures of a surveillance inspection are for identity and condition.

#### 5-2. STORAGE

a. **30-Day Limitation.** Currently, the eggs stored by the military are either fresh or processed fresh. Because any military procurement of shell eggs involves some storage either at the distribution point or in shipment, the specification requirement that shell eggs not be in storage for more than 30 days prior to shipment is rigidly adhered to.

b. **Guidelines for Cold Storage.** Cold storage is not a perfect method for preserving shell eggs. After long periods of storage, the eggs begin to deteriorate and may develop off- flavors. Because of the long period of immobility, storage eggs usually appear a grade higher when they are candled than they actually are when they are broken out. A Check egg that has been stored comes out a Loss egg. Cold storage of eggs follows a seasonal storage cycle, with the largest number of eggs stored during the spring and the largest number withdrawn in the autumn and winter. The least number of eggs are stored in February and March. Thus, the time of year that they are withdrawn from storage has much to do with the quality of eggs offered for inspection. If eggs are to be stored for a long period, a temperature of 29° to 32°F (-2° to 0°C) is recommended. If storage is to be for only a few days to 2 weeks, such as at the Commissary or Post Exchange, a maximum temperature of 35°F (2°C) is required. The proper relative humidity is 88 to 92 percent, and its constancy depends on the constancy of the temperature. This humidity prevents water loss from the egg and it is the level that is least conducive to mold growth. When eggs are removed from long-term cold storage, they should be tempered to 35°F (2°C) slowly over a period of 18 to 24 hours. This keeps moisture from condensing on the shell and prevents microbial growth and spoilage.

### 5-3. TREATING EGGS

a. **Oil Processing.** All military procurements of shell eggs for oversea shipments and many domestic shipments are oil-treated to seal the pores. This prevents contamination, absorption of offensive odors and flavors, and loss of moisture.

(1) Treatment. For oil treatment to be effective, the egg must be dipped or sprayed as soon as possible after the egg is laid. Mineral oil that is tasteless, odorless, and colorless must be used for the processing. Heavy mineral oils are more effective than those with low viscosity, but they must be heated to a temperature higher than the temperature of the egg to flow easily. Vegetable oils are not acceptable because of the oxidation that occurs during storage.

(2) Method. Federal specifications state that, when eggs are oil-processed, the oil must be applied by immersion or by spraying, a substantial amount of the shell covered, and the area surrounding the air cell completely covered. The method of application varies from hand-dipped and drained to the complicated wheel arrangement and spraying used to treat large quantities. The spray method has advantages over immersion since it:

- (a) Reduces the number of Check eggs.
- (b) Eliminates eggs being broken in the processing oil.
- (c) Is more sanitary.
- (d) Requires less labor, thus is less expensive.

b. **Thermostabilization.** Thermostabilization is also used to preserve shell eggs. At a temperature of approximately 40°F (4°C), shell eggs are placed on a movable metal belt and conveyed under a continuous stream of oil at a temperature of 132° to 134°F (56° to 57°C) for approximately 15 minutes. This permits a thin layer of albumen to coagulate immediately adjacent to the shell membranes. The treated, warm shell eggs, which then have an internal temperature of approximately 120°F (49°C), are packed and placed in a cooler at 30° to 35°F (-2° to 2°C) until shipment. Thermostabilization is helpful because it:

- (1) Seals the pores, supplementing the cuticle.
- (2) Helps prevent absorption of foreign odors.
- (3) Helps prevent dehydration.
- (4) Helps prevent loss of gaseous carbon dioxide.
- (5) Destroys the fertile germ cell.

#### **5-4. SELECTING SAMPLES**

- a. Samples should be drawn so as to be representative of the lot, but special attention is paid to obtaining some of the sample units from possible areas of storage stress, such as along warehouse walls, near the ceiling, close to cooling coils and doors, etc.
- b. One hundred percent inspection of the entire lot will be performed at the request of a responsible quality assurance element or when sampling inspection results indicate a 100 percent inspection is necessary (provided that personnel and equipment are available).
- c. The same sample may be used to perform condition and identity inspection.
- d. If performing a Class 9 inspection at a DPSC supply point, sampling inspection will be in accordance with DPSC Manual 4155.7. If performing a Class 9 inspection at a commissary operation, sampling procedures will be in accordance with local SOP.
- e. If performing a Class 5, 6, 7, and/or 9 inspection, every effort will be made to ensure that only serviceable supplies are shipped, stored, issued, and/or received. This may require up to a 100 percent inspection.
- f. For the actual procedure of withdrawing samples from sample cases, see Lessons 2, 3, and 4 of this subcourse.

#### **5-5. IDENTITY INSPECTION**

Identity inspection is a determination that the product is that specified on the container and/or shipping documents. If necessary, the primary containers of the product will be opened for examination.

- a. When performing a Class 6 inspection at a DPSC supply point, the inspector will ensure that stock being shipped is from the warehouse lot number listed on the shipping document.
- b. A factor to be considered in the shipping of shell eggs is that those that have been in storage longest are normally those shipped first. This is the rule of first in, first out (FIFO).

## 5-6. CONDITION INSPECTION

Condition inspection is an inspection to detect deteriorative conditions in shell eggs and to ensure that the packaging and packing are in such condition as to protect the product during storage and distribution.

a. **Inspect the Conveyance, if Applicable.** See Lesson 5 of Subcourse MD0694 for further information about the inspection of conveyances.

- (1) In a Class 5 or 6 inspection, inspection of a conveyance is required.
- (2) In a Class 7 inspection, an inspection of a conveyance may be necessary.

b. **Inspect the Storage Area, if Applicable.** See Subcourse MD0717 for further information about proper and improper sanitary procedures in food storage facilities.

- (1) In a Class 9 inspection, an inspection of the storage area is necessary.
- (2) In a Class 7 inspection, an inspection of a storage area may be necessary.

c. **Evaluate the Adequacy of Packaging and Packing.** The packaging and packing must be inspected to ensure that it will adequately protect the shell eggs during further storage and distribution. The shipping containers will be free of tears, rips, cuts, crushing, and/or damage from water.

d. **Determine the Age of the Shell Eggs.** See Lesson 6 of Subcourse MD0694, Basic Food Inspection Procedures, for further information about the age of a product.

e. **Verify the Temperature of the Product.** See Lesson 4 of Subcourse MD0694 for further information about the measurement of product temperature.

f. **Prepare Candling Room and Assemble Egg Inspection Equipment.** See Lesson 1 of this subcourse.

g. **Classify Shell Eggs.** See Lesson 3 of this subcourse. During the candling and classifying process in surveillance inspections, primary emphasis must be placed on Loss eggs (such as mold growth, stuck yolks). Secondary importance is placed on the determination of grade. Immediately upon opening the case, it is of utmost importance that the inspector note any musty odor coming from the case and packing material.

## **5-7. REPORTING DEFICIENCIES**

All deficiencies (any defect that affects the usability of the shell eggs for their intended purpose) and age of product noted by the inspector are reported to the supervisor and/or accountable officer in accordance with local SOP. Necessary reports will be completed as required.

## **5-8. DETERMINING DISPOSITION OF SAMPLES**

All samples that have been destroyed will be replaced from one carton or case so as to fill all cartons or cases except one. If samples were selected, they will be returned to the accountable officer, placed back into the lot, or destroyed in accordance with local SOP. See Lesson 2 of Subcourse MD0704, Inspection Records and Reports, for further information about the disposition of samples.

**Continue with Exercises**

## EXERCISES, LESSON 5

**INSTRUCTIONS:** The following exercises are to be answered by marking the lettered response that best answers the question or best completes the incomplete statement or by writing the answer in the space provided.

After you have completed all the exercises, turn to "Solutions to Exercises" at the end of the lesson and check your answers.

1. The basic inspection procedures of a surveillance inspection of shell eggs are for \_\_\_\_\_ and \_\_\_\_\_.
  
2. Shell eggs should not be in storage for more than:
  - a. 30 days.
  - b. 45 days.
  - c. 60 days.
  - d. 75 days.
  
3. The recommended storage temperature for shell eggs that are to be stored for a long period is \_\_\_\_\_.
  
4. The proper relative humidity, of a cold storage facility, for shell egg storage is \_\_\_\_\_.
  
5. When candling eggs during a surveillance inspection, greater emphasis should be placed on identifying Loss eggs rather than making a grade determination.
  - a. True.
  - b. False.



6. Shell eggs are oil-treated so as to prevent:
- a. \_\_\_\_\_.
  - b. \_\_\_\_\_.
  - c. \_\_\_\_\_.
7. When selecting samples for a surveillance inspection of shell eggs, strict random sampling is required.
- a. True.
  - b. False.
8. A Class 6 inspection at a DPSC supply point must ensure that stock being shipped is from the warehouse lot number listed on the shipping document.
- a. True.
  - b. False.
9. When performing a Class 9 inspection, you are not required to inspect the storage area.
- a. True.
  - b. False.
10. When shell eggs are shipped from one military installation to another (Class 6), the conveyance used to transport the eggs must also be inspected.
- a. True.
  - b. False.

**Check Your Answers on Next Page**

## SOLUTIONS TO EXERCISES, LESSON 5

1. Identity and condition (para 5-1)
2. a (para 5-2a)
3. 29°to 32°F (-2° to 0°C) (para 5-2b)
4. 82-92 percent (para 5-2b)
5. a (para 5-6g)
6. Contamination  
Absorption of offensive odors and flavors  
Loss of moisture (para 5-3a)
7. b (para 5-4a)
8. a (para 5-5)
9. b (para 5-6b(1))
10. a (para 5-6a(1))

**End of Lesson 5**